

**SUTHERLAND SHIRE  
JUNIOR CRICKET ASSOCIATION, INC.**

**1992 - 1993**

**36TH ANNUAL REPORT**

**and**

**FINANCIAL STATEMENT**



Ken Whatley - President

B. Probert - Hon. Secretary

R. Brennan - Hon. Treasurer

P. Schofield - Hon. Competition Secretary

**SUTHERLAND SHIRE JUNIOR CRICKET ASSOCIATION, INC.**

NOTICE is hereby given that the adjourned THIRTY SIXTH ANNUAL GENERAL MEETING of the above Association will be held at the Cricket Administration Centre, Caringbah Oval on 22 June, 1993, at 8.00pm sharp.

**BUSINESS**

1. Read and confirm minutes of previous Annual Meeting.
2. Apologies.
3. Correspondence.
4. Welcome visitors.
5. Consideration of Annual Report of the Management Committee and Hon. Treasurer's Financial Statement
6. Notices re alterations to rules.
7. Election of Officers.
  - (a) Patrons
  - (b) President
  - (c) Vice Presidents
  - (d) Hon. Secretary
  - (e) Hon. Treasurer
  - (f) Hon. Competition Secretary
  - (g) Hon. Assistant Secretary
  - (h) Hon. Recorders
  - (i) Hon. Registrar
  - (j) Hon. Publicity Officer
  - (k) Committee of Three
  - (l) Hon. Auditors
8. Such other business as may be brought forward in conformity with the rules of the Association.

**-- A CORDIAL INVITATION IS EXTENDED TO YOU TO ATTEND --**

34 SIANDRA DRIVE,  
KAREELA 2232.  
PHONE: 525-4302

BRIAN PROBERT  
HON SECRETARY

OFFICE BEARERS - 1992/93

PATRONS

V Ridge T. Icton

PRESIDENT

K. Whatley

VICE PRESIDENTS

Alan Craston

Harry Peters

HON SECRETARY

B. Probert

34 Siandra Drive

Kareela. 2232.

Phone: 528-4826

HON ASSISTANT SECRETARY

B. Phillips

HON PUBLICITY OFFICER

B Ross

HON. COMPETITION SECRETARY

P Schofield

26 Rawson Parade

Caringbah 2229

Phone: 523-1902

HON TREASURER

R Brennan

HON REGISTRAR

M. O'Brien

HON RECORDERS

Bev Stanford, Jan Chalmers

COMMITTEE MEMBERS

V. Routh, I. Chalmers

DEL TO S.D.C.C.

G Blakeley

DEL TO N.S.W.J.C.U. DEL TO S.S.C.U.A.

R. Eaglesham

I. Chalmers

LIFE MEMBERS

J. Daly (Dec.), J. Moodie, R. King, (Dec.) W. Croucher, M. Edson, C. Thompson,  
F. Malbon (Dec.), N. Davies, J. Ratty, R. Hilditch, K. Prendergast, Mrs. I. Ratty,  
F.R. Pattison, J. Bannon, L. Handley, K. Whatley, D. Clark, J. Lynch, K. Gardner,  
S. Steed, D. Masters, B. Quinn, W. Lawler, R. Brennan

SUB-COMMITTEES

GRADING COMMITTEE:

Exec. Members, G. Davis, P. Hamilton, P. Schofield,  
A. Craston, J. Chalmers, B. Stanford, M. O'Brien  
G. Blakeley

REP CO-ORDINATOR:

Ken Whatley, Peter Schofield, a Vice President.

DISPUTES & PROTESTS:

Ken Whatley

BUILDING TRUSTEE:

U/16s: D. Mann, P. Schofield, K. Holley

SELECTION:

U/15s: T. Woodhill, D. Holley, R. Manning

U/14s: J. Campbell, T. Clark, F. Lake

U/13s: B. Probert, M. Lumb, S. Duff

U/12s: S. Routh, P. Thomson, G. Hilzinger

U/11s: B. Phillips, A. Craston, T. Gleeson

U/10s: F. Reid, M. O'Brien, T. Whittingham

S. Steed, R. Duff

HON AUDITORS:

TO ALL MEMBERS

OF THE

SUTHERLAND SHIRE JUNIOR CRICKET ASSOCIATION

Ladies and Gentlemen,

On behalf of the Executive of your Association I now present to you the Thirty-sixth Annual Report and Financial Statement for your approval and adoption.

Sutherland Shire Junior  
Cricket Association

Brian Probert  
Hon. Secretary

# WE SET THE TREND

OUR COMPETITORS FOLLOW  
LIKE SHEEP

- The LARGEST SELECTION of Cricket Gear in Australia
- A genuine desire to give you service and advice on every facet of the Cricket Business
- All at discounted prices
- Clubs & Schools catered for

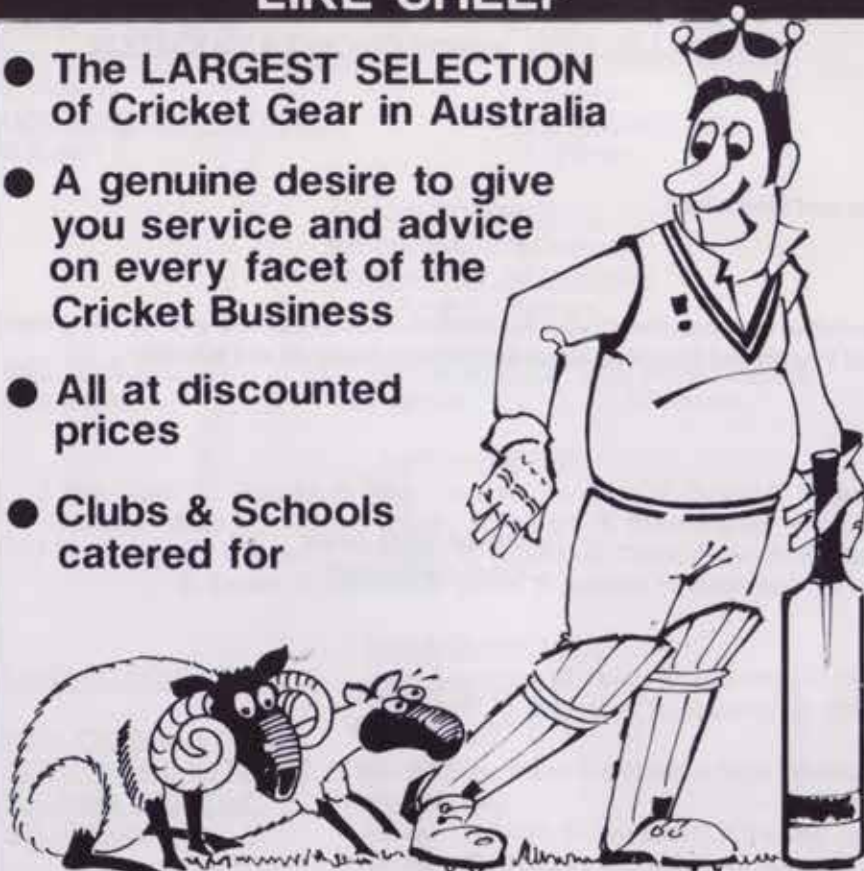

PHONE or CALL IN FOR OUR SUPER MAILORDER CATALOGUE

**KINGSGROVE SPORTS CENTRE**

"THE KINGS OF CRICKET"

247-249 KINGSGROVE ROAD, KINGSGROVE, NSW, 2208

Telephone: (02) 50 8775 or (02) 502 1174 Fax: (02) 502 4503

## PRESIDENT'S MESSAGE

This past year has been an exciting year for our Association. First up, our Moore Shield team won its final in the Junior Union Competition and to Fred Lake and his team, congratulations. All teams performed well and the boys were a credit to our Association.

Congratulations to Caringbah Sports in again winning the Club Championship and six premierships, which I think would be a first.

An effort was made to get an U/8 competition off the ground. Unfortunately, arrangements were a little late, not giving clubs sufficient time to organise teams. To the clubs that did participate, a good time was had by all. The coming of the 1993/94 season will see a bigger effort made to increase the numbers of our U/8 teams.

One of the most pleasing things to come out of this season was the terrific support received from the grade club secretary, Kevin Holley who supplied grade players as selectors for our Representative teams and arranged coaching days. The grade club also had first grade players visiting schools in our shire during the cricket season. Kevin is also on our U/8 promotion team for the coming season. To Kevin Holley and the grade club, a big thanks from our Association.

Alan Craston did not stand for Secretary this year and our new Secretary, Brian Probert, did a great job. To our Committee; Ray Brennan, Treasurer; Peter Schofield, Competition Secretary; Recorders Bev Stanford and Jan Chalmers; Greg Godkin who took on the job of Public Relations and was also responsible for arranging the sponsorship for our representative teams, also to the rest of the Committee thank you all for a job well done. To our sponsors, thank you for your support and we hope our members support you and your products. To the Managers, Coaches, Club Secretaries, Scorers, Mums and Dads, thank you for your cooperation for another successful cricket season.

KEN WHATLEY  
PRESIDENT.

## CRICKETER OF THE YEAR

### MATTHEW BRADLEY - CARINGBAH SPORTS

Matthew comes from the strong Caringbah Sports Club with whom he has played all his junior cricket. From the moment I laid eyes on him as a very small nine year old, it was always obvious to me he had something special. Starting off his career as a right hand batsman, and medium pace outswing bowler, it didn't take long for Matt to show his class, scoring a brilliant century in the victorious Foster Shield Team's march to the finals. His performance in both club and representative teams, earned him a place in the N.S.W. Squads, captaining these sides from U/13 to U/16, also being chosen in the N.S.W. PSA team at the age of 12. Matthew toured Queensland in the U/13 and U/15 Metropolitan sides, captaining the team on both occasions. It was not until his later years that his bowling also started to improve. This is due to Matthew's attitude, not only in the game but his commitment to training is first class. Matthew has played two years Green Shield and in his final year, he captained the Sutherland side to a fabulous victory over St. George at Hurstville Oval. In his final year in junior cricket, Matthew has really blossomed, batting well above his years. His achievements this year have been little short of outstanding. He captained Sutherland Green Shield side, captained Watson Shield side and leading Caringbah Sports 16A to a fine premiership win. The Sutherland Grade Club has recognised Matthew's immense talents, grading him this year and again Matthew performed outstandingly, moving quickly from 5th to 4th grade with little difficulty. I have had the privilege of being involved with Matthew for quite a few years now and have no hesitation in saying Matthew is one of the best batting prospects to come from junior cricket in Sutherland for many seasons. A sound technique, beautiful footwork and tremendous timing certainly make him an outstanding cricketer. This year in junior cricket, Matthew scored 342 runs and took 14 wickets. I look forward to following Matthew's career and wish him all the best for the future. A worthy winner! Well done Titch!

### PETER SCHOFIELD

Also considered C. Lucas, Caringbah Sports; C. Hockey, Gymea; J. Skinner, Gymea, W. Schofield, Caringbah Sports; S. Peters, Caringbah Sports; D. Eaglesham, Gymea.

## BEST PERFORMANCE 14A - CHRIS LAKE, ENGADINE SUTHERLAND DISTRICT CRICKET CLUB AWARD

Chris has played all his junior cricket with the Engadline Club, commencing in 1987/88 in the 10A's. Over this period, Chris has amassed a total of 2,291 runs and captured 72 wickets. Chris has also represented the Sutherland Shire in the Foster, Creak, Cawsey, Gee and Moore Shields. He has had success in three of these sides, Creak, Gee and Moore, also being captain of the Gee and Moore Shield teams. Chris's talents have not only been confined to club and shire cricket, he is also involved in the Metropolitan squad. Chris is a fine competitive cricketer, at club or representative level and thoroughly deserves this award.

Chris's figures for the 1992/93 season - 643 runs at 71.44 and 19 wickets at 9.21. Also considered: Brendan Wicks (Como-Jannali), Craig Brownscombe (Engadline), Ben Ronald (Illawong), Adam Brodbeck (Caringbah Sports), Daniel Godkin (Caringbah Sports).

## BEST PERFORMANCE 12A - SCOTT McGEACHIE, ILLAWONG SUTHERLAND UNITED SERVICES CLUB TROPHY

Scott McGeachie from Illawong 12A is a conscientious and committed cricketer and he is to be congratulated as the winner of this award. This season, his talents were equally divided, having amassed 420 runs at an average of 42 and 34 wickets at an average of 6.4. Scott proved to be a solid player in the 12A competition and captained his side with maturity, always bringing to the game sportsmanship. Scott's commitment, competitiveness and enthusiasm will undoubtedly lead to many more runs scored and wickets captured in the seasons ahead. Scott has also represented the Sutherland Shire in junior cricket.

Also considered: G. Harris (Sylvania), D. Lucas (Caringbah Sports), R. Stafford (Sylvania).

## BEST PERFORMANCE 10A - JUSTIN DRINKWATER, ILLAWONG LEN GILAM TROPHY

Justin Drinkwater from Illawong is a fine young cricketer and is to be commended for having been awarded this prestigious trophy for the second consecutive year. Justin's all round ability is well demonstrated, a most determined batsman, scoring 384 runs at an average of 54.86 and a talented bowler, capturing 26 wickets at an average of 5.38 during the 1992/93 season. Congratulations, Justin, we look forward to watching your career grow as you mature.

Also considered: S. Reid (Como Jannali), H. McGeachie (Illawong) P. Cuff (Como Jannali).



# Kingsgrove Cricket Academy

## OPENING SOON!

CRICKET COACHING and PRACTICE FACILITIES FOR CRICKETERS OF ALL AGES ORGANISED AND RUN BY AUSTRALIA'S PREMIER CRICKET STORE... KINGS GROVE SPORTS CENTRE... THE MOST PRESTIGIOUS INDOOR TRAINING FACILITY IN AUSTRALIA!

## Facilities available

- \* FOUR INDOOR PRACTICE NETS with MAXIMUM RUN-UPS
- \* BOWLING MACHINES
- \* FIELDING PRACTICE FACILITIES (Slips cradles)
- \* INDIVIDUAL COACHING ANY DAY or NIGHT (Year time)
- \* GROUP COACHING
- \* QUALIFIED COACHES (Hand picked for specific coaching)
- \* SPECIAL CLINICS THROUGH SCHOOL HOLIDAY PERIODS
- \* SPECIALISED COACHING CLINICS run by INTERNATIONAL CRICKETERS THROUGHOUT THE YEAR  
eg: Bunting skills, fast and spin bowling clinics
- \* SPECIALIST CLINICS THROUGHOUT THE YEAR, EVEN ON WEEKDAY EVENINGS
- \* CONVENIENCES SUCH AS CHANGE ROOMS and SHOWERS ETC
- \* PERMANENT HEAD COACH: - *Brad McNamee* - NSW State Team

**179 Kingsgrove Rd  
Kingsgrove NSW 2208**

*For further information please contact Hannah Solomon the Centre Manager BH: (02) 502 3211 or (02) 502 4533  
Fax: (02) 502 4503  
POSTAL ADDRESS: - P.O. Box 31 Kingsgrove NSW 2208 AUSTRALIA*

### OTHER AWARDS

CLUB CHAMPIONSHIP  
BEST REPRESENTATIVE TEAM PERFORMANCE  
REPRESENTATIVE ACHIEVEMENT AWARD  
CRICKETER OF THE YEAR  
BEST PERFORMANCE - 14A  
BEST PERFORMANCE - 12A  
BEST PERFORMANCE - 10A  
BEST ASSOCIATION BATTING PERFORMANCE IN TRADITIONAL CRICKET  
BEST ASSOCIATION BATTING PERFORMANCE IN MODIFIED CRICKET  
BEST ASSOCIATION BATTING PERFORMANCE IN INTRODUCTORY CRICKET  
BEST BOWLING PERFORMANCE U/16 & U/14  
BEST BOWLING PERFORMANCE U/12 & U/10 TRADITIONAL CRICKET  
BEST BOWLING PERFORMANCE IN INTRODUCTORY CRICKET  
BEST ASSOCIATION WICKET KEEPER  
MOST CATCHES U/16 & U/14  
MOST CATCHES U/12 & U/10  
ENCOURAGEMENT WICKET KEEPING AWARD IN INTRODUCTORY CRICKET  
BEST ASSOCIATION SCORE BOOK

BERTSHELL TROPHY  
ALAN WARD MEMORIAL TROPHY  
CLIFF PADDY MEMORIAL TROPHY  
  
THE CHATLAND AWARD  
S.S.J.C.A. AWARD  
S.S.J.C.A. AWARD  
ROBERT TICKNER TROPHY  
CLAUDE MANN TROPHY  
CLAUDE MANN TROPHY  
DON MASTERS TROPHY  
KEN WHATLEY TROPHY  
BOB HILL TROPHY

CARINGBAH SPORTS  
MOORE SHIELD  
C. LAKE ENGADINE 14A  
M. BRADLEY CARINGBAH SPORTS 16A  
C. LAKE ENGADINE 14A  
S. McGEACHIE ILLAWONG4 12A  
J. DRINKWATER ILLAWONG 10A  
C. LAKE ENGADINE 14A  
A. HOUSTON MIRANDA 12D  
A. McBARRON ILLAWONG 10D  
J. CATT CARINGBAH D.L.S. 16B  
S. McGEACHIE ILLAWONG 12A  
A. DELLER CRONULLA SEAGULLS 10C  
T. REYNOLDS GYMEA 16A  
D. GODKIN (16) CARINGBAH SPORTS 14A  
T. DALFORNO (13) ST. JOHN BOSCO 12C  
M. ETTRICK SYLVANIA 10D  
C. MURRAY GYMEA 14D

## SECRETARY'S REPORT

### The Season Under Review.

Undoubtedly the highlight of the 1992/93 season was Sutherland's magnificent victory over St. George in the Green Shield final. Those who witnessed the match were treated to an exhibition of first class cricket. The victorious Sutherland side comprised of the complete U/16 Watson Shield team, all locally coached junior cricketers, a complete team effort.

The Representative season saw a number of new faces in coaching positions and although not quite as successful as the previous season, Sutherland still produced finalists in the Harold Moore Shield, Walter Gee Shield and semi-finalists in the Foster Shield. Congratulations to Fred Lake, Coach/Manager and Greg Godkin, Asst. Manager and the Moore Shield team for their convincing win in the Shell Shield Final.

The 1992/93 season also produced a record number of Sutherland juniors selected in the N.S.W. Metropolitan Squads, an indictment of the Representative teams' coaching staff.

Due to the diligence of the S.S.J.C.A., the season ran very smoothly with few hiccups and although interrupted by bad weather, the finals were very successful, watched and enjoyed by a large number of spectators.

This year the introduction of U/8 teams has slightly boosted our numbers and I am sure with a little foresight and forward planning by some clubs, this age group will prosper, thus ensuring a continuing growth in our ranks for the forthcoming seasons. It is very heartening to see more parents participating in coaching and umpiring courses. This can only be beneficial to junior cricket in the Shire.

With the financial support from the N.S.W. State Government's Department of Sport, Recreation and Racing Capital Assistance Program, new synthetic turf has been laid on Oyster Bay, Gwawley North, Boystown, Scylla Bay and Woronora Heights. More wickets have also been allocated to be returfed for the 1993/94 season, a fine achievement by the S.S.J.C.A. Committee. The grounds, although still not up to scratch have improved but simply there are far too many sporting codes playing on too few grounds.

Presentation Night in June 1992 was again successfully organised by the effervescent Ivor Chalmers at the Cronulla Sutherland Leagues Club, Ivor being ably assisted by Jan Chalmers and Bev Stanford. The 1992 Cricketer of the Year Award was presented to the talented Jason Holley from the Gynea Club.

Finance - As detailed in the Hon. Treasurer's Report.

Inter Association Competitions. Because of the amalgamation of St. George and Georges River, the Rob Allen and the Executive Trophy have been combined. These trophies have been traditionally sought after by St. George, Georges River and Sutherland. The Allan Ward and Mort Edson Shield awarded for the Best Representative Team was won by the U/14 Moore Shield Team.

The prestigious Representative Cap Presentation was held at Cronulla-Caringbah Junior Rugby League Club. The layout, facilities and hospitality contributed to a very successful event.

Thanks and appreciation to:

The hard working S.S.J.C.A. Committee.

Sutherland Grade Club and Secretary Kevin Holley.

The Umpires Association - President Jim Lynch for their provision of officials throughout the season.

Vince Ridge, Secretary of the Mens Association for his continued cooperation and encouragement.

Tom Icton, President of the Grade Club for assistance with turf wickets.

Sutherland Shire Council, in particular Colleen Stahlhut and Peter Hickman for their help and expertise in ground allocation and management.

To all sponsors for their continued support of Sutherland Junior Cricket.

And a very special thank you to Jan Chalmers and Peter Schofield for their tireless effort and dedication to junior cricket in the Sutherland Shire for many years. Peter and Jan, your presence will be sorely missed.

BRIAN PROBERT  
SECRETARY

## TREASURER'S REPORT

The 1992/93 season proved to be a difficult one financially, necessitating for the first time application of a levy on all Representative players. Such action was not taken lightly but was caused by the ever increasing cost of putting rep teams on the field and the other pressures on our overall finances.

Despite these problems, we were able to lay 3 replacement synthetic wickets and purchase a word processor to give the Association a high level of professionalism.

A key feature of the season was the support given by our rep sponsors, without the \$5200 from this source, we would have been in dire straits. Harry Peters was again out front sponsoring two teams. Please give all our sponsors the support they have given us and deserve in return. Their advertisements appear throughout this report.

Our finances remain in a good position and we look forward to the next season together with the challenges it will bring.

Thank you once again to all Club Secretaries for your cooperation during the season.

RAY BRENNAN  
TREASURER

STATEMENT OF ASSETS AND LIABILITIES AS AT 30TH APRIL 1993

**LIABILITIES**

Provisions for Additional Expenditure from 1992/93 season		
- Trophies and Engraving	\$ 1,000-00	
- Annual Report	2,500-00	
- Presentation Night	<u>600-00</u>	\$ 4,100-00
Club Affiliation Deposits		\$ 500-00
<b>Accumulated Funds</b>		
Opening Balance	\$27,246-17	
General Operating Surplus	2,569-76	
Insurance Surplus	<u>903-53</u>	\$30,719-46
		<u>\$35,319-46</u>

**ASSETS**

Bank - Cheque Account	\$ 7,284-42	
- Term Deposit	<u>16,199-16</u>	\$23,483-58
<b>Insurance Funds</b>		
Bank - Cheque Account	703-70	
- Investment Account	<u>9,332-18</u>	\$10,035-88
<b>Fixed Assets</b>		
Computer Equipment (at cost)	2,309-80	
Less Depreciation	<u>709-80</u>	\$ 1,600-00
(All other Assets fully depreciated)		
Prepayment		\$ 200-00
		<u>\$35,319-46</u>

We declare that the books and supporting documents have been checked and in our opinion the above statements present a true and fair view of the affairs of the S.S.J.C.A. as at 30th April, 1993

R. J. DUFF (HONORARY AUDITOR)

R. C. BRENNAN (HONORARY TREASURER)

INSURANCE ACCOUNT

Team Insurance	\$ 486-00	Claims Paid	\$ NIL
Interest Received	418-07	Government Taxes	0-54
Balance at Bank - 30/4/92		Balance at Bank - 30/4/93	
- Cheque Account	\$ 207-54	- Cheque Account	703-70
- Investment Account	<u>8,924-81</u>	- Investment Account	<u>9,332-18</u>
	\$ 9,132-35		\$10,035-88
	<u>\$10,036-42</u>		<u>\$10,036-42</u>



FINANCIAL STATEMENT FOR SEASON ENDED 30TH APRIL 1993

**RECEIPTS**

Accounts Rendered on Clubs	\$18,836-00	
Advertising 1991/92 Annual Report	140-00	
Contributions by SSCA & SDCC	580-90	
Donations	65-00	
Chatland Trust	26-32	
Interest Received	1,015-98	
Rep Sponsorships	5,215-00	
Buttercup Promotion	1,516-00	
Dept of Sport/Rec Grant	2,035-00	
Affiliation Fees - SSCUA	20-00	
Rep Players Levies	<u>3,360-00</u>	\$32,810-20

<u>Balance at Bank 30 April 1992</u>		
- Cheque Account	\$ 9,501-60	
- Investment Account	<u>15,447-22</u>	\$24,948-82
		<u>\$57,759-02</u>

**PAYMENTS**

<u>Presentation Night</u>		
Annual Report	\$ 2,396-00	
Trophies & Engraving	2,090-00	
Other Expenses	253-10	
1993 Deposit	<u>200-00</u>	\$ 4,939-10
<u>Representative Series</u>		
Balls	\$ 1,680-10	
T-Shirts	3,180-10	
Caps	1,831-20	
Umpires	1,447-50	
Photos	924-30	
Miscellaneous	<u>429-56</u>	\$ 9,492-76
<u>General Expenses</u>		
Honour Board	\$ 70-00	
Printing, Copying etc	934-95	
Insurance	871-37	
Purchase of Scorebooks	880-00	
Affiliation - NSWJCU	680-00	
Honoraria	1,560-00	
Govt Taxes	63-36	
Insurance Levy	486-00	
Synthetic Wicket Expenses		
- new wickets	5,959-50	
- repairs	568-30	
Buttercup Promotion	3,751-00	
Rule Books	800-00	
Computer Equipment	2,309-80	
Postages	151-05	
Ground Maintenance	250-00	
Under 8 Competition	382-50	
Miscellaneous Expenses	<u>125-75</u>	\$19,843-58

<u>Balance at Bank 30 April 1993</u>		
- Cheque Account	\$ 7,284-42	
- Investment Account	<u>16,199-16</u>	\$23,483-58
		<u>\$57,759-02</u>

**EXECUTIVE REPORTS**

COMPETITION SECRETARY'S REPORT.

The 1992/93 season was very similar to the 1991/92 season. We had in total 81 teams, plus three U/8 sides, which is exactly the same number as last season. This is a pleasing figure in as far as not losing any teams, but we are always keen to increase our numbers further. The U/8 competition was run in conjunction with two sides from Ramsgate R.S.L. I must congratulate Carlingbah Sports, Sylvania and Miranda for their efforts to enter sides in the U/8 competition. I feel some of the clubs showed little or no interest in this competition whatsoever and if this attitude continues, I feel the trend in Sutherland Juniors will be to drop a number of teams each season. On the plus side, Sylvania club has made a concentrated effort to recruit boys, run the teams and club professionally. They are to be congratulated, while Como-Jannali also seem to be going in the right direction. The extra involvement of the Illawong Cricket Club is also a healthy sign and more clubs should make a concentrated effort to get people on the Executive of the Association.

The finals again were a big success and thanks must go to all the people involved, teams, clubs and umpires.

To Carlingbah Sports, congratulations in winning the Club Championship again, surely the results of a well run club.

The Representative teams while not as successful in terms of winning Shields still went very well and every team was competitive. We had more boys try out for the Rep sides this year and I stress that Clubs must play a big part in advising all boys to go to the trials.

Thanks also to the Senior club, they have made a tremendous effort to help the Juniors whenever asked. Kevin Holley and Tom Ieaton must be congratulated for their efforts.

I look forward to the day when we have only one Cricket Association in the Shire, Seniors and Juniors as one. Who knows, maybe one day.

To all our sponsors, thanks again for all your contributions, without people like you, Junior cricket would not exist. To our hard working Committee, thanks again for a job well done, special mention to Bev Stanford and Jan Chalmers, Recorders, for Chalmers who spends hours working unselfishly for Junior Cricket and to Brian Probert, who in his first season as Secretary has done a terrific job. I have been in this job for the past three years and feel it has been long enough, I thank the Committee for all the help and assistance they have given me. In standing down, I wish the whole of Sutherland Cricket well and hope we never lose sight of what we are about, KIDS.

PETER SCHOFIELD  
COMPETITION SECRETARY.

## RECORDERS' REPORT

Firstly, may we congratulate the boys/girls who have won trophies for their performances throughout this season.

There was controversy regarding the regrading of teams and the teams taking their points up with them from the lower grade. There does not seem to be an easy answer as to the fairness of this but you should also consider that the teams going up are put at a disadvantage. They are the leaders in the lower grade where they are more than likely to be in a position to win and then they are elevated to a higher grade. This may result in them then being at the bottom of that higher grade (although their points may not put them in that position) and usually have to face a tougher competition at the higher level. This season one of the teams did go on to become minor premiers in the higher grade but this is very unusual. The other team did not fare as well.

It is disappointing to see that some teams continue to bat out of order after the recorders have gone to the trouble to give the rotating batting teams their batting order for the round to their club delegates for them to follow. We don't know the answer to this.

The wet weather rule seems to be giving some coaches/managers problems. If you are unsure of the rule, check with your Club management for clarification and if they aren't sure then they should check with an association committee person. The recorders don't like to deduct points for minor breaches but we have to abide by the rules in the Rule Book.

The score books this year were of a reasonably high standard which makes our life a bit easier at the end of the season.

I would like to congratulate the boys from Gynea 12D. Week after week this team of young men have battled. On 6 occasions they had to bat twice but managed to avert an outright loss on all but one occasion, but in their final game they had their first win. Not only did they win, but they beat the Premiers. Congratulations boys, stick at it, I'm sure that you will have more wins come your way next season.

Finally, I'd like to say how I've enjoyed my years as recorder, but I have decided not to nominate for the 93/94 season, so there will be a vacancy for another person, hopefully from another club to assist Bev in the recording duties.

Beverly and I would like to pass on our best wishes to the young men who will leave the junior ranks and to wish them well as they graduate to men's cricket or grade cricket.

JAN CHALMERS

BEVERLY STANFORD

## PUBLIC RELATIONS REPORT

I would firstly like to thank all players, parents and officials for the manner in which you have represented the Sutherland Shire Junior Cricket Association. Although competitive, the Sports(person)ship, which drives our Saturday morning competition is the prime reason for the success of this Association. Congratulations to all.

Sponsorship has also been recognised as a major contributor to the future of our game. The economic factors which surround us certainly place a strain on the Association purse strings. Without the financial backing of the following sponsors, life would be just a little more difficult. MPM Premium Seafoods, AVCO Finance, St. George Bank, Caltex Refining Company Pty. Ltd., Stewart Toyota, Berts Soft Drinks, Kingsgrove Sports Store.

Congratulations to all who participated in this year's Shell Series, with three teams again making it through to the finals. The Foster Shield, The Gee Shield just missing out on winning their fourth consecutive final, and to the Moore Shield for winning the U/14 final - this team has lost only one game in five years, the Watson, Weblin and Creak Shield teams were also proud representatives of our Association. All of our valued sponsors received great recognition throughout the season and all players carried their respective sponsors and Association logos with pride.

Junior Cricket in the Sutherland Shire is producing a wealth of good cricketers and steps are already in place for next season to ensure that our growth continues.

Marketing junior cricket in the Sutherland Shire is made a lot easier by the way in which all players conduct themselves on and off the field, as most companies like to be associated with developing the type of sportsperson they would like to reflect their business. Thank you to all parents, players and executive committee members for their participation and assistance throughout the year.

GREG GODKIN

PUBLIC RELATIONS OFFICER

## PUBLICITY OFFICER'S REPORT:

Cricket is over for another season but it will be upon us again before too long. There were many positive things to come from the past season. One thing that must be mentioned is the introduction of the U/8 Competition. This has been a tremendous success and the boys enjoyed the non-competitive atmosphere of their cricket. All of the boys' cricket improved as the season progressed and the delight on their young faces as they learned the skills of the game was something special.

Congratulations to all the Premiership winning teams and especially to Caringbah Sports for winning the Club Championship. I would like to thank each of the Executive for their help and support during the season. Unfortunately, it is becoming harder to obtain the publicity that is necessary to help our association in the way it

should be helped. Frank Dowling and Shire Monthly newspaper are always available to help us and for this I thank him. Our local community radio station 2SSR FM which is situated at 99.7 on the FM dial is always keen to help. Next season I hope to have a regular session on this station and each club will be given the details.

Finally, I would like to thank all the players. We have some great young people and some great young players in the Sutherland Shire competition. We are very fortunate in this regard and I sincerely hope everybody who is still U/16 will play again in the 1993/94 season. See you next season and bring some friends with you.

BARRY ROSS  
PUBLICITY OFFICER

ooo0ooo

FAMOUS FIRSTS

WHO WAS THE FIRST PLAYER TO:

- .. MAKE 100 CONSECUTIVE TEST MATCH APPEARANCES?
- .. SCORE A CENTURY AND DOUBLE CENTURY IN THE SAME TEST?
- .. SCORE 1000 TEST RUNS AGAINST 4 DIFFERENT COUNTRIES?
- .. DON BRADMAN WAS THE FIRST BATSMAN TO SCORE 25 TEST CENTURIES. WHO, THOUGH, WAS THE FIRST BATSMAN TO SCORE 50 HALF CENTURIES?
- .. WHO WAS THE FIRST BATSMAN TO SCORE A DOUBLE CENTURY IN A TEST MATCH AGAINST 5 DIFFERENT COUNTRIES?
- .. HOW MANY LEFT HANDED BATSMEN HAVE SCORED 10 OR MORE TEST CENTURIES FOR AUSTRALIA?
- .. A DAVIS CUP TENNIS PLAYER WHO MADE HIS TEST DEBUT FOR INDIA AT THE AGE OF 40?



COACHING TIP NO.

MAKE IT LOOK SPECTACULAR, EVEN IF IT IS A DOLLEY

REGISTRAR'S REPORT - 1992/93 SEASON

Below are details of registrations accepted by the Sutherland Shire Junior Cricket Association for the 1992/93 season.

<u>REGISTERED CLUBS</u>	<u>NO. OF TEAMS</u>	<u>NO. OF PLAYERS</u>
CARINGBAH SPORTS	11	135
COMO JANNALI	8	102
CRONULLA SEAGULLS	4	48
DE LA SALLE CARINGBAH	2	25
ENGADINE DRAGONS	6	76
GYMEA BAY	8	99
HEATHCOTE	2	28
ILLAWONG	14	160
MARTON	1	14
MIRANDA MAGPIES	7	87
ST. JOHN BOSCO	4	51
ST. PATRICKS	8	97
SYLVANIA HEIGHTS	9	107
<u>TOTAL = 13 CLUBS</u>	<u>84</u>	<u>1029</u>

TOTAL NO. OF FEMALE PLAYERS = 9

NO. OF PLAYERS AND TEAMS BY AGE GROUP

<u>AGE GROUP</u>	<u>PLAYERS</u>	<u>TEAMS</u>
U/8	31	3
U/10	223	18
U/12	299	24
U/14	300	25
U/16	176	14

MICK O'BRIEN, REGISTRAR

## CALTEX REFINERY LIMITED

Proud sponsors of the Under 10 team and supporters of  
the Sutherland Shire Junior Cricket Association.

Congratulations to the Sutherland U-10's in making  
the semi-final of The Foster Shield.



### W.G. FOSTER SHIELD

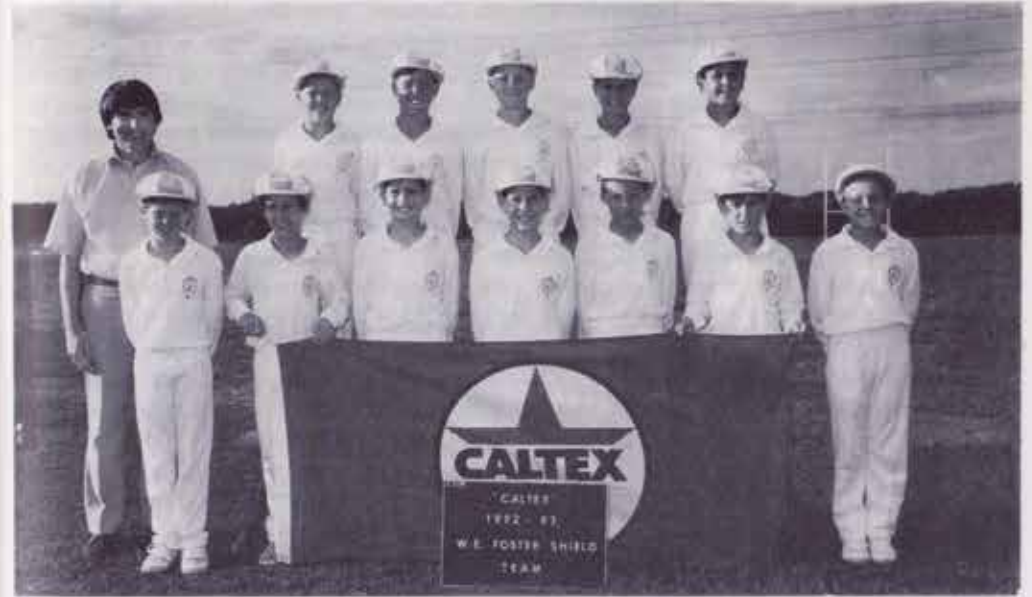

Back Row (L-R): Frank Reid (Manager), Nick Cole, Blake Kennedy  
Justin Drinkwater, Nathan Trajcevski, Ben Hodgson

Front Row (L-R): Clifford Oates, Matthew Barnes, Matthew O'Neill,  
Simon Reid (Captain), Paul Culff, Adam Fleming,  
Cameron Davis

Over recent years, Sutherland has had very fine Foster Shield Teams, and our team in 1992/93 was no exception. We won four of the five games in the Shell Series and reached the semi-finals. Only two teams, Newcastle and Georges River-St. George defeated us all summer and they contested the final.

The team's strength lay in its outstanding fielding and fine bowling. Brilliant catches were taken in all parts of the field and accurate throws resulted in many vital runouts.

Outstanding among our bowlers was off spinner, Nick Cole who picked up 18 wickets in 6 games. Our opening bowlers, Cameron Davis and Justin Drinkwater bowled with great hostility and were never mastered by any opening batsman. They were superbly assisted by Simon Reid, Matthew O'Neill, Nathan Trajcevski and Adam Fleming.

The batting was less consistent but highlights of the season included Simon Reid's 100 n.o. and 43, Justin Drinkwater 55 n.o. and 49 as well as courageous and valuable innings by both Nathan Trajcevski against Camden and Ben Hodgson against Newcastle. The team was very well captained by Simon Reid who led with enthusiasm and determination and did a fine job organising the bowling. Team spirit was high right throughout the series and all members of the team were committed to give their best whether in the games or in practice. I congratulate all players on and off the field. In this regard, they were fine ambassadors to our association. I thank all boys who were made 12th man during the series and who carried the drinks with such good grace. The man on the hill also gives his best wishes to all players and thanks you all for an enjoyable season.

To succeed in Representative cricket, one needs two good teams. One team of players and one team of parents. I was very fortunate in having a wonderful team of supportive and helpful parents to whom I give grateful thanks. Thank you to all our scorers and to everybody for the very enjoyable afternoon teas. Special thanks to John Drinkwater who umpired in several games, selectors Tony Whittingham and Mick O'Brien and also Peter Schofield for his help and support.

The financial costs of outfitting Representative teams are very high and we are indebted to Caltex for their generous sponsorship and hope Caltex will continue to support the junior cricketers of the Sutherland Shire. I thank the Association for giving me the opportunity of coaching at Representative level. It has been demanding but most enjoyable and rewarding.

Finally I thank my wife Ruth and my family for their encouragement and support throughout the season and for doing many of the unseen tasks necessary in managing a Representative team.

FRANK REID.  
MANAGER.

#### MATCH RESULTS.

#### TRIAL GAMES

Sutherland 149 - Nathan Trajcevski 45, Simon Reid 35 ret. defeated Canterbury-Wests 63. N. Trajcevski 2/4, N. Cole 2/3.

Sutherland 75 - lost to Georges River/St. George 182.

#### SHELL SERIES

Sutherland - 2 dec. 118 - J. Drinkwater 55 n.o., defeated Gordon 7/49. N. Cole 4/9, J. Drinkwater 2/7 and 8-37 - S. Reid 2/2, N. Cole 2/8.

Sutherland - 7/148 - S. Reid 43 defeated Penrith 8-104, S. Reid 3/14, N. Cole 3/22.

Sutherland - 8/105 - defeated Camden 81. N. Cole 4/21.

Sutherland - 48 and 2/21 lost to Newcastle 63. C. Davis 3/7, N. Cole 3/13 and 4/52 dec. S. Reid 2/9.

Sutherland - 1/191, S. Reid 100 n.o., J. Drinkwater 49 defeated Hornsby-Kuringai 168. N. Trajcevski 2/22.

Semi Final Sutherland 19 lost to Georges River/St. George 6-130, N. Cole 2/18, J. Drinkwater 2/30.



PRODUCT OF THE SUTHERLAND SHIRE

BUY DIRECT FROM THE FACTORY AT  
**WHOLESALE PRICES**

- \* Soft Drinks
- \* Cordials
- \* Cans
- \* Mixer Drinks
- \* Low Calories
- \* Pure Fruit Juices

Sugar  A natural part of life



45-47 ALEXANDER AVE, TAREN POINT  
TELEPHONE: 525 3033

Open 7.30 a.m. to 5.00 p.m. Mon. to Fri.  
7.30 a.m. to 11.30 a.m. Sat.

## J.H. CREAK MEMORIAL SHIELD



Back Row (L-R): B. Phillips (Asst Mgr), T. Moreland, M. Hadfield,  
B. Phillips, C. Rosman, B. Jacobs, T. Gleeson (Mgr)

Front Row (L-R): J. McInnes, T. Hughes, J. Muhs, T. Glennan (C),  
C. Beattie (VC), G. Morriss, S. Laws

Following the trials in October, we were full of confidence for the coming Representative series. This was an enthusiastic yet inexperienced side as there was only 5 players left from the previous Foster Shield Team. Our first training runs convinced us that this was a team that could go very well this year. The trial matches confirmed this with 3 wins from 3 games. It was obvious, however, that our batting was going to be the weak part of our game. We regularly showed that we could bat out the 50 overs but we only scored more than 100 twice in 8 matches. Even though we were unable to improve on last season's performance, there were a number of highlights that gave us great confidence for the next season. Troy Glennan came of age as a Captain, his performance on the field with bowling changes and field placings was excellent and he led by example with the bat, scoring 97 runs at 10.78.

The best performed players were in the field with John Muhs leading the way, bowling 78 overs for 8/116, 1.49 runs per over. John McInnes with his superbly controlled leg spin bowling took 11/161 off 65 overs and regularly made the break through. Newcomer Todd Hughes 5/48, Scott Laws 4/82, and Mark Hadfield 3/13, together with Geoff Morris 5/113 gave tremendous support at all times. The best example of what the team could do was in Round 4 against Penrith. At tea Penrith were 2/47 chasing 106 to win with 21 overs remaining. Even Penrith were confident, Sutherland performed magnificently. Ben Phillips led the way taking 6/11 from 9 overs, bowling his leggies into a stiff southerly wind. Tim Moreland capped off a great series taking 5 wickets behind the stumps (15 dismissals for the season). We also witnessed 3 of the best outfield catches seen at this level of cricket and Penrith were all out for 82 off the last ball. The boys proved that they were amongst the best bowling and field teams in the series.

Even though batting was our weakness, there were signs of strength, Clinton Beattie scored 152 runs at 19.00, scoring at a run a minute, with a bit of patience he will be great. Ben Jacobs (77 @ 11.00) started well with some good scores but was unable to score quickly enough. Casey Rosman (107 @ 13.38) and Geoff Morriss (69 @ 8.63) showed great improvement towards the end and again Scott Laws and Todd Hughes showed a lot of promise.

Tony's and my thanks go to all the parents for their support throughout the season. The boys always got to games on time, there was always a scorer, afternoon teas were sumptuous and a great time was had by all. A special thanks to Raellen & John Muhs, and Elinka and Don Jacobs for opening up their homes to us all, it helped make an enjoyable season even better.

I look forward to the opportunity to be involved with next year's Cawsey Shield team with the knowledge that the boys will be more competitive following this year's experience. All we ask is that they continue to do their best and compete with the high quality of sportsmanship that was shown this season.

### BARRY PHILLIPS ASST. MANAGER

### MATCH RESULTS

#### TRIAL GAMES

Sutherland 78 defeated Canterbury-Wests 62.  
Sutherland 93 defeated Bankstown 91.  
Sutherland 9/122 defeated GRP/St. George 6/103 (Ben Jacobs 39).

#### SHELL SERIES

Sutherland 76 lost to Gordon 5/124, 2/31.  
Sutherland 6/98 lost to Fairfield/Liverpool 4/100 (Casey Rosman 32).  
Sutherland 86 and 4/51 defeated Hornsby 38, 9/80 (Casey Rosman 34, Troy Glennan 3/19, John McInnes 4/20).  
Sutherland 7/105 defeated Penrith 82 (Ben Phillips 6/11).  
Sutherland 6/90 lost to Northern Districts 4/134.

**GOOD REASONS WHY ALL CATERING MANAGERS SHOULD READ THIS PAGE**



Breaded Fish Portions



Tempura Garlic Prawns



Breaded Fish Portions



Crispy Fried Fish with Dipping Sauce



Seafood Patties  
Crabbed Sticks



New Coconut Breaded Prawns



**PREMIUM QUALITY SEAFOODS AT AFFORDABLE PRICES**

*For enquiries call Australasian Food Service Agents:*

**MARINE PRODUCT MARKETING PTY. LTD.**

LEVEL 16 • 207 KENT STREET, SYDNEY, N.S.W. 2000, AUSTRALIA

PHONE (02) 251 4310 • TELEX AA72776 • FAX (02) 251 4141

PRIVATE FAX (02) 528 2523

MELBOURNE — NICHIREI AUST. (03) 654-6266

BRISBANE — QUEENSLAND SEAFOOD BROKERS (07) 890-1171



**ARCH CAWSEY SHIELD**



Back Row (L-R):

M. Peters, G. Thomson, K. Hilzinger, S. Cowley,  
S. McGeachie, M. McGeachie (Asst. Manager),  
S. Routh (Manager).

Front Row (L-R):

H. Peters, K. Stewart, A. Myers, R. Stafford, D. Lucas (C)  
D. Mitchell, B. Routh (VC), G. Harris

It has been a privilege to coach a team that has shown so much commitment and enthusiasm from the first training session to the last, and the first match to the last.

We commenced the Shell series with a convincing win over Hawkesbury: batting first we posted 150 runs on the board and the opposition were unable to measure up against a fine display of bowling and fielding. After this match, we went north to meet Gosford/Wyong in what we felt would be the hardest game of the series. After losing

the toss, we were asked to bat and managed only 87 runs. however, we were able to dismiss them for 72 with superb bowling, catching and ground fielding, resulting in one of the best games of junior cricket I have had the pleasure of watching.

Our next three games were not to go our way. We were beaten easily by Penrith, lost by 1 run against Camden and only 3 runs against Northern Districts.

The Boys represented the Shire with a great deal of pride, displaying sportsmanship and behaviour on and off the field that we all should be proud of. Daniel Lucas captained the team and with the support of all the boys did a fine job.

All junior sports are costly, representative cricket is no exception and I must thank Harry and Carol Peters for their generous sponsorship and total involvement in the team throughout the series.

I would also like to thank Mark McGeachie my Assistant Manager, Ann McGeachie, Peter Cowley, Chris Mitchell and Phil Thomson for their talents with scoring, the parents, grandparents and friends for their support for the boys and myself and the ladies who provided afternoon teas for the home games. We were fortunate in that Gynea Rugby League club made its clubhouse and facilities available to us which was appreciated. In closing, I would like to thank the committee of the S.S.J.C.A. for allowing me the opportunity to coach a Representative team and to the team for making it such a rewarding venture.

STEVE ROUTH  
MANAGER



COACHING TIP

ALWAYS APPEAL AS IF YOU MEAN IT



**AVCO**  
**IS A**  
**PROUD**  
**SPONSOR**

**OF JUNIOR CRICKET**  
**IN THE**  
**SUTHERLAND SHIRE**

**AVCO WISHES TO**  
**CONGRATULATE THE 1992/93**  
**GEE SHIELD TEAM FOR REACHING**  
**THEIR FOURTH CONSECUTIVE**  
**FINAL!**

**WELL DONE TO THE BOYS,**  
**COACH AND PARENTS.**



## WALTER GEE SHIELD



Back Row (L-R): B. Ronald, C. Thomas, M. Probert (C), N. Ross, C. Gray, B. Probert (Manager).

Front Row (L-R): N. Davis, M. Uebel, A. Davis, M. Heslehurst (VC), D. Reynolds, T. Fenech, D. Tozer

Well, we nearly made it 4 shields in a row! And it certainly wasn't through the lack of trying. The boys again played extremely well although other sporting commitments interfered with some players' attendance at training. As was pointed out at the start of the season, Representative games will only get harder as the players get older and to succeed, there must be total commitment.

Throughout the season, our bowling and fielding was first class but our batting strength left a little to be desired. Again, undefeated up to the final, and what a day to play cricket. It was obvious to ardent cricket followers that winning the toss meant starting the match with a tremendous advantage, no such luck, and being Champions, we did not receive any favours. But to their credit, the Sutherland boys tried to the very last ball and were very gracious in defeat. The team as always represented the S.S.J.C.A. with pride and distinction.

Due to Wayne Ronald's (General Manager of Avco Finance), generosity and financial support, the Sutherland Gee Shield Team's attire was impeccable. The Avco logo was displayed at the Darling Harbour Sports Show where the team was invited to demonstrate their cricket prowess, also at the Annual Leader Sports Star Awards where the boys were rewarded for being the best performed Representative team in N.S.W. of any age for the 1991/92 season.

Thanks to Ron Gray for his expertise and statistics in scoring and to their parents for their generous hospitality. Thanks also to the Grade Club, in particular Matthew Lumb and Shane Duff for giving their time in selecting the team.

Congratulations to Cameron Gray, Murray Heslehurst, Matthew Probert, Darren Reynolds and Mark Uebel for being selected in the U/13 N.S.W. Metropolitan Squad, with Matthew and Darren successfully captaining the side against the A.C.T and Newcastle respectively.

## MATCH RESULTS

### TRIAL GAMES:

Sutherland vs Illawarra - Sutherland 180 defeated Illawarra 106. Chris Thomas 4/10.  
Sutherland vs Georges River/St. George - Sutherland 7/130 defeated St. George 110.  
D. Reynolds 32 ret. M. Probert 34 ret.

### SHELL SHIELD:

Sutherland vs Illawarra - Sutherland 2/78 defeated Illawarra 100 on run rate. C. Thomas 4/13.  
Sutherland vs Gordon - Sutherland 4/147 defeated Gordon 145. C. Gray 56 n.o., M. Uebel 35.  
Sutherland vs Manly - Sutherland 7/115 defeated Manly 9/68. M. Probert 37, C. Thomas 5/14.  
Sutherland vs Blacktown - Sutherland 7/135 defeated Blacktown 77. M. Probert 56 n.o., B. Ronald 4/2.  
Sutherland vs Parramatta - Sutherland 115 tied with Parramatta 115. M. Probert 34.  
Semi Final: Sutherland vs Parramatta - Sutherland 4/132 defeated Parramatta 116.  
A. Davis 3/30, C. Gray 3/21, N. Ross 43, C. Gray 32, M. Probert 32.  
Final: Sutherland vs Camden - Camden 4/96 defeated Sutherland 5/92. C. Thomas 2/15, C. Gray 20, M. Probert 20, M. Uebel 21 n.o.

Thanks Team for another great year.

BRIAN PROBERT  
MANAGER

Janside Ply Limited (Inc. in NSW) A.C.N. 003 484 455 trading as

# STEWART TOYOTA

STEWART TOYOTA No.1 IN THE SUTHERLAND SHIRE

AND PROUD SPONSORS OF

THE SUTHERLAND SHIRE JUNIOR CRICKET ASSOCIATION

STEWART'S No.1 IN - SALES

- SERVICE
- SPARE PARTS

## HAROLD MOORE SHIELD

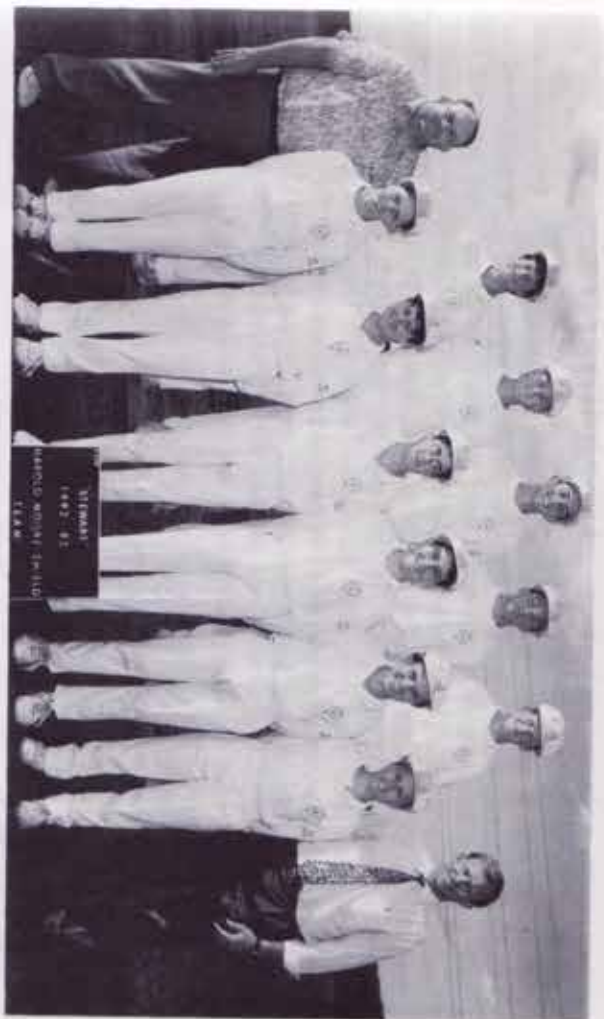

Back Row (L-R):

Paul Reid, Daniel Godkin, (VC), Chris Lake (C),  
Adam Brodbeck, Brendan Wicks

Front Row (L-R):

Fred Lake (Manager), Paul Hadfield, Craig Brownscombe,  
Stephen Hair, Craig McNamara, Mark Howell,  
Stuart Rooney, Greg Godkin (Asst Manager),  
Stephen Carlisle (Absent)

Once again, it gives me great pleasure to write this report about a champion team, the 1992/93 N.S.W. Junior Cricket Union Moore Shield Champions. This proved to be back to back wins for a great majority of these boys and in fact leaves this age group with a record of only one loss in five years. Surely, some sort of Junior Union record.

It could be truly said that daylight ran second to these boys as none of their games were really close. They were such a great bowling and field side that even moderate scores could be defended easily. All the boys displayed total commitment and the side was very capably led by Chris Lake and Daniel Godkin.

It would remiss of me if I only talked about the boys' cricket abilities and results because their sportsmanship and behaviour were exceptional also. They were at all times worthy ambassadors for Sutherland Shire and this is a reflection of their families and their cricket clubs. I congratulate them both.

I would like to express my sincere appreciation to the following individuals and groups because without their contributions, the team would not have performed as well as it did and everyone connected with the team would not have enjoyed the season, as we all did. Many thanks to: Asst. Manager, Greg Godkin, who did such a marvellous job, the scorers, Paddy Godkin and Bev Stanford, Brenda and Mick Rooney, Denise McNamara, David Hair and all the parents. All the parents contributed in one way or another during the season. Thanks to the ladies for preparing and serving afternoon teas the Association's Executive for their support and attendance at Semi Final and Final, our sponsors Stewart Toyota for their great financial assistance, Sutherland Shire umpires who did an excellent job and Engadine Eagles Soccer Club for use of their canteen and their facilities.

FRED LAKE  
MANAGER

#### MATCH RESULTS

The season began with two easy trial wins over Illawarra and Georges River/St. George.

#### SHELL SERIES

Sutherland 7/183 defeated Illawarra 87. C. Lake 72, M. Howell 33, S. Hair 30 n.o., B. Wicks 5/18, A. Brodbeck 2/11.

Sutherland 2/223 defeated Blackdown 8/107. B. Wicks 93 n.o., C. Lake 85, A. Brodbeck 36, D. Godkin 3/17.

Sutherland 9/121 defeated Penrith 93. C. Brownscombe 26, B. Wicks 21, C. Brownscombe 2/12, A. Brodbeck 2/13.

Sutherland 3/268 defeated Gladesville 99. A. Brodbeck 140 n.o., C. Lake 72, D. Godkin 33 and 4/28, B. Wicks 3/8.

Sutherland 9/196 defeated Camden 83. S. Hair 37, S. Rooney 34, C. McNamara 34 and 4/13, D. Godkin 3/19.

Semi Final - Sutherland 9/125 defeated Manly 59. S. Hair 33 n.o., B. Wicks 19, A. Brodbeck 3/6, S. Carlisle 3/7 (incl hat-trick).

Final - Sutherland 7/177 defeated Georges River/St. George 86. C. Lake 40, B. Wicks 53, A. Brodbeck 42 and 2/11, C. Brownscombe 2/20. Sutherland winning the Final by 1 runs.

Congratulations to Chris Lake on gaining the batting award for the Harold Moore Shield, Chris batted for 5 innings for an aggregate of 264 runs at an average of 52.80. A wonderful effort!

**St. George Bank**  
**supports all cricketers**  
**in the**  
**Sutherland Shire.**

*What a great idea*  
**St. George** 

**E.G. WEBLIN MEMORIAL SHIELD**



Back Row (L-R): D. McCrea, D. McLauchlan, D. Adams, R. Thomas, T. Cadden, D. Dobie (MHR)  
 Front Row (L-R): K. Furner (Manager), I. Cuff, D. Marcic, R. Furner, S. Manning (C), P. Grey, B. Kennis, R. Manning (Coach)

Despite not making the finals, the team had a very successful season, winning three out of five; as they were drawn in a tough division made up of 3 of last year's semi-finalists. The team combined exceptionally both on and off the field. The support from all parents was outstanding with special thanks to Kevin Furner for managing, Col Adams and Eric Marcic for scoring.

Our first game against the eventual winners, Parramatta, was a great effort and with a little luck, we could have been winners and continued with more confidence. The team was well led by Scott Manning, with the strength of the team continuing to be the fielding and very tight bowling. Our batting again was a little fragile on occasions but all the players improved and gave their best. Best performances with the bat were Ben Kennis, Derek Adams, and Darren McCrea, whilst Russell Thomas, Daniel McLauchlan and Derek Adams shone with the ball.

The team have committed themselves to an off season of batting practice to ensure that they are prepared for the challenges of their last year in junior cricket.

Thank you to the SSJCA for the opportunity to be associated with such a fine group of cricketers.

**BOB MANNING**  
**MANAGER**

**GOOD REASONS WHY ALL CATERING MANAGERS SHOULD READ THIS PAGE**



Tempura Prawns



Crumbed and Fried Wings



Teriyaki Garlic Prawns



Seafood Fishes and Seafood Steaks



**PREMIUM QUALITY SEAFOODS AT AFFORDABLE PRICES**



Breaded Fish Portions



New Coconut Breaded Prawns

*For enquiries call Australasian Food Service Agents.*



**MARINE PRODUCT MARKETING PTY. LTD.**  
 LEVEL 16 • 207 KENT STREET, SYDNEY, N.S.W. 2000, AUSTRALIA  
 PHONE (02) 251 4310 • TELEX AA72776 • FAX (02) 251 4141  
 PRIVATE FAX (02) 528 2523  
 MELBOURNE — NICHIREI AUST. (03) 654-6266  
 BRISBANE — QUEENSLAND SEAFOOD BROKERS (07) 890-1171



## WATSON SHIELD



Back Row (L-R): W. Schofield, J. Skinner, C. Lucas, M. O'Brien, B. Sommerville  
Front Row (L-R): H. Peters (Asst. Manager), D. Eaglesham, J. Abeleven, S. Peters, M. Bradley, (C), T. Reynolds, M. Eades, C. Hockey, P. Schofield (Manager)

Well as Rep series go, we have had better, it seems since the Cawsey year anything that can go wrong will. Two rained out games, one played on 6.0 synthetic and that about sums up the series. Very disappointing indeed. The one consolation is that this team went on to win the prestigious Green Shield, so there is some justice in the world after all. The efforts and behaviour of the boys was again exemplary, as in past years. Our Captain, Matthew Bradley, led the team very well in a job which is never easy. To our Scorers, Mick O'Brien and Judy Eaglesham, thanks for your hours of work on the team's behalf, to Harry Peters, my Manager for the last 6 seasons - thanks Harry and Carol for all the work you have done for the boys, not only managing the team but for your generous sponsorship and helping junior cricket in any way possible. To all the boys, I wish you all the best, not only in cricket but in what life offers you. It has been a great pleasure to have been associated with you, your parents and your club can be very proud of you, I certainly am. Thanks for the memories.

SCHOIE  
MANAGER

## MIRANDA MAGPIES CRICKET CLUB

After perhaps our strongest recruiting drive ever, we managed to field 6 boys teams, the same as the previous season. We also fielded an U/8 team, which I feel was a good effort as Miranda has a much smaller population base in this age group than some of the larger clubs who could not manage to get a team together. Miranda were successful in the 14D and 12C grades, both teams defeating Sports in the Final. Our club's thanks go to all involved in the administration of the boys' competition for their hard work in running what is really an excellent competition.

BILL FOSTER  
SECRETARY

## ST. PATRICK'S CRICKET CLUB

This year St. Pats fielded 8 teams in the competition, one down on last year. The numbers in the 14's and 16's were encouraging but not so in the younger groups where we had two U/10 teams and only one U/12 team. Our 14B team won the premiership after losing their first competition game then winning 10 games straight to take out the competition in brilliant style. St. Patrick's Cricket Club would like to congratulate all premiership winners from other clubs and also to Caringbah Sports for winning the Club Championship. Lastly to Sutherland Shire Junior Association Committee, we thank you for a job well done.

WARREN DALEY  
REGISTRAR

### ILLAWONG CRICKET CLUB

The 1992/93 season saw Illawong Cricket Club emerge as the largest club in the Sutherland Shire Junior Cricket Association, with two U/16 teams, five U/14, three U/12, four U/10 teams. While it is good to see growth within our club, this meant that some of our teams were unfortunate enough to be graded in the same competition. This is unavoidable when growth is restricted to one club and not spread throughout the shire. For this reason, I encourage and support the Association in its attempt to recruit more boys to the game but also more clubs to the Association.

Four of our teams played in Finals. 10A, 12A, 12B, and 10D1 and although we were unable to win any, it is pleasing to see the lower age groups competing in Finals, an indication of things to come.

Several boys in all teams achieved their personal best during the season and I congratulate them and all the teams for their sportsmanship and competitiveness. Eight Illawong boys were selected to represent the Sutherland Shire Cricket Association in the Rep teams, something they should all be very proud of. In closing, I would like to thank the Executive Committee for their efforts to ensure a successful season and to Caringbah Sports for winning the Club Championship.

STEVE ROUTH  
SECRETARY

### ST. JOHN BOSCO CRICKET CLUB

The 1992/93 season saw Bosco field four teams. The Club Executive congratulate our U/10C team win their respective competition as well as their coach Mick Madigan. Our teams also fared very well with the 14D and 12C just missing the finals. We extend our sincere thanks to coaches, managers, scorers, and parents who gave great support to our players during the season. Our congratulations go to Caringbah Sports on winning the Club Championship and to the winners of all the respective competitions.

No season can operate successfully without a hard-working Committee. We extend our thanks to the S.S.J.C.A. for making the season so successful and enjoyable for the players. I would also like to thank the Bosco Committee for the support during the season and look forward to the 1993/94 season.

JOHN HENRY  
PRESIDENT

### CRONULLA SEAGULLS CRICKET CLUB

The 1992/93 season saw our Club field four teams, one in each age group. Although the Club did not win a premiership, two sides performed very well and missed the finals by the smallest of margins. It is becoming difficult to recruit new players to our club, mainly due to the ageing and somewhat moving population in the Cronulla area. This is of concern to our Committee. Congratulations to all award winners and Premiership winning teams. Finally to the Committee of the S.S.J.C.A., thank you for your efforts in organising and successfully running the junior competition. The boys enjoyed their cricket again due to your efforts.

ROB TUCKER  
SECRETARY

### COMO JANNALI CRICKET CLUB

After two years of solid growth, the 1992/93 season started disappointingly. We failed to register enough boys to form an U/16 team and our overall numbers mainly because of a drop off in the 14's as well as the 16's were down on the previous year. We formed eight teams that all were well graded and we looked forward to an excellent season. Our 14A team was given the opportunity to christen the new pitch at Scylla Bay and delighted us by winning every game they played there. All our teams produced some outstanding performances and in the end, we finished up having our most successful season, winning the 10A and 12D premierships. We also achieved 4th place in the Club Championship.

We wish to thank all our managers and coaches for their dedication and hard work throughout the season. They were ably backed up by many parents who gave great support. We had 12 boys who represented the Sutherland Shire in the Shell Series and as always they did themselves and their club proud with some very fine performances.

We support the Association in their endeavours to capture as many young players as possible by introducing an U/8 competition and trust that the increased promotional activity will attract some of the older boys back that we lost last year. Our thanks to the Association for another enjoyable season of cricket.

GERALD DAVIS  
VICE PRESIDENT



Let

share

the driving with you.

#### ENGADINE DRAGONS CRICKET CLUB

This season we fielded six teams, the same as for the 1991/92 season. The 14A team was our only success, being minor premiers and runners up in the Competition. We had a large involvement in the Reps with many boys gaining selection in various Rep sides. Of these, three boys were successful in the Moore Shield Premiership side, coached by our 14A's Fred Lake. During the season, our club became incorporated thanks to the tireless work of our Mens Secretary Adrian Vannan. On behalf of myself and the Engadine Dragons Cricket Club, I would like to congratulate all award winners and premiership teams and to thank the S.S.J.C.A. Committee for their efforts in making the 1992/93 season most enjoyable.

JOHN UEBEL  
SECRETARY

#### SYLVANIA HEIGHTS COMMUNITY YOUTH CLUB

The Heights finished the 1992/93 season a very satisfied club. We were able to field nine teams in the S.S.J.C.A. competition and we had four teams in the Finals, our 12A team as premiers, our 10C team minor premiers, and we were one of only three clubs in the Shire to field an U/8 team. Our Committee and supporters are very enthusiastic and this showed in the fact that we were able to hold our Presentation Night on the 27th March. This Presentation and sausage sizzle afterwards was a great success. We thanked Harry Peters who represented the Association for his support.

There were 170 boys registered in nine teams. We had four teams, 10C, 12A, 12D, 14B in the finals. Five of our players were selected for representative teams. These were Simon Cowley, Grant Harris, Rodney Stafford, Scott Laws and Nick Davis. We congratulate these boys in achieving this honour. A number of performances stand out this season but one that should be mentioned is that of Grant Harris from our 12A team. Grant scored 453 runs at an average of 113.25 and backed that up with 18 wickets at an average of 12.77. Well done Grant.

On the long weekend in January, we again run our successful double wicket competition for our U/12 and U/14 players. This is now part of our season calendar. One of the extremely positive aspects of our Club is the support we receive from a great many people. This season, we had all teams with a good coach, assistant coach, manager and scorer and many other people who were prepared to offer assistance when needed. We thank all these people and congratulate them for a job well done.

From outside the club we receive great support from Greg Ball Miranda; St. George Bank were supportive and our year book sponsors also made a very valuable contribution. To all these people we offer our very strong vote of thanks. We also thank the Sutherland Grade Club players who came along to practice sessions and attended some games. The junior players really appreciate the support shown by the senior players. Of course the season and competition would not be possible without all the other clubs who compete each week. The standard of both cricket and sportsmanship was very high and we thank all other clubs for the very positive spirit in which the games were played. We certainly look forward to another season in 1993/94.

We all know that Committees are the group of people who start off building a horse but end up with a camel. I am delighted to say that Ken Whatley and his team are one group who know how to build a horse. The support of the Committee was top class and the organisation of the competition was very good. Thanks S.S.J.C.A. Committee for a job well done.

**KEN MORRISON**  
**SECRETARY**

### GYMEA BAY CRICKET CLUB

In the 1992/93 season, Gymea fielded eight teams. We had two teams in the finals. Although we didn't win a premiership, we did finish second in the Club Championship and that was pleasing to the Club as it indicated the overall standard of all the teams' performances. Gymea Bay is a large club, eight boys and twelve mens teams. I would like to thank my own club committee for their support during the season. We had a strong representation in the Rep teams and I congratulate all Rep players on their selection. Congratulations to Caringbah Sports for winning the Club Championship and for the performance of winning six premierships. Perhaps the only disappointing aspect of the season was the instances of teams losing points and thus missing the finals because of innocent errors on the part of team managers. Quite often the rule infringement has no bearing on the outcome of the game. Some of the rules that affect the boys' enjoyment of the game need to be re-evaluated as more often than not the penalty does not fit the crime. Finally, I would like to thank the Association Committee for donating their time to organise another successful season.

**PETER HAMILTON**  
**SECRETARY**

## GOOD REASONS WHY ALL CATERING MANAGERS SHOULD READ THIS PAGE



Breaded Prawns/Dillies



Crumbed Prawns/Rings  
Breaded Dillies



Tempura (Shrimp/Prawns)



Seafood Flakes  
Seafood Sticks



**PREMIUM QUALITY SEAFOODS  
AT AFFORDABLE PRICES**



Breaded Fish Portions



New Coconut Breaded Prawns

*For enquiries call Australasian  
Food Service Agents:*



**MARINE PRODUCT MARKETING PTY. LTD.**  
LEVEL 16 • 207 KENT STREET, SYDNEY, N.S.W. 2000, AUSTRALIA  
PHONE (02) 251 4310 • TELEX AA72776 • FAX (02) 251 4141  
PRIVATE FAX (02) 528 2523  
MELBOURNE — NICHIREI AUST. (03) 654 6266  
BRISBANE — QUEENSLAND SEAFOOD BROKERS (07) 890 1171





## CARINGBAH SPORTS CRICKET CLUB INC.

Congratulations to the new Association Secretary, Brian Probert, on a successful first year and to Competition Secretary, Peter Schofield, on another well run season. Also to the officials and members of our Moore Shield team on winning their competition for Sutherland.

Sports have had another successful year but it is tinged with a little regret as it sees an end of an era with Peter Schofield's highly successful 16A team ending their junior cricket days. Peter not only taught these boys to play well, he also taught them the meaning of fair play, dress sense and good conduct. They have been an ornament to the game, to this club and to the Sutherland Shire in their time in the juniors and, which is more important, they have been a credit to their families and themselves. I am sure that every fair minded person wishes them well in their future careers.

My own personal thanks goes to all who assisted cricket in the shire in any way during the season and especially to my own club executive and members who have once again been great. Thanks also to the sponsors at both Association and club level, they have made the running of the game much less demanding. Best of luck to everyone in the 1993/94 season.

IVOR CHALMERS  
SECRETARY

oooOooo

### ANSWERS TO FAMOUS FIRSTS QUIZ

- .. SUNIL GAVASKAR
- .. DOUG WALTERS (242 & 103 VS WEST INDIES 1968-69)
- .. COLIN COWDREY (2433 VS AUSTRALIA, 1751 VS WEST INDIES, 1133 VS N.Z. 1021 VS SOUTH AFRICA).
- .. LEN HUTTON
- .. JAVED MIANDAD
- .. 4 - ALLAN BORDER, NEIL HARVEY, BILL LAWRY, ARTHUR MORRIS
- .. COTA RAMASWAMI



Telephones: 524 6613  
525 3709  
524 6581  
A.H. 522 9387  
Fax: 540 1063  
CAR: 018 281 383

## **DON MASTERS PTY. LTD.**

REAL ESTATE AGENTS, REGISTERED VALUERS,  
PROPERTY AND STRATA MANAGEMENT  
599b KINGSWAY, MIRANDA 2228



DON MASTERS  
DIRECTOR



## **PERSONALISED AWARDS**

*(The Trophy Specialists)*

62 Parthenia Street, Dolans Bay, N.S.W. 2229  
Telephone: 525 2205

*An invitation is extended to your Organisation to inspect our latest range of Sporting Trophies.*

*We would only be too happy to arrange a range of samples to your Committee for their consideration.*

*Our product is backed by 30 years of experience in the Trophy Industry and our prices are lower than our competitors.*

*We are also specialists in personalising Trophies.*

*To offer you our full attention, we would request that if you should be interested in our products, please phone us for an appointment.*

*Assuring you of our best attention at all times.*

KEN WHATLEY

CLUB CHAMPIONSHIP

<u>CLUB</u>	<u>NO. OF TEAMS</u>	<u>POINTS</u>
CARINGBAH SPORTS	10	121.6
GYMEA BAY	8	94.7
ENGADINE	6	93.7
COMO JANNALI	8	81.3
ILLAWONG MENAI	14	78.2
SYLVANIA	8	73.8
ST PATRICKS	8	67.0
CARINGBAH D.L.S.	2	67.0
MARTON	1	61.5
MIRANDA MAGPIES	6	46.7
ST JOHN BOSCO	4	37.4
CRONULLA SEAGULLS	4	36.3
HEATHCOTE	2	18.0

The 13 Premierships were shared by 7 clubs as follows:

CARINGBAH SPORTS	16A, 16B, 14A, 14B, 12B, 10D
COMO JANNALI	12D, 10A
MIRANDA MAGPIES	14D, 12C
ST PATRICKS	14B
SYLVANIA	12A
ST JOHN BOSCO	10C

S.S.J.C.A. COMPETITION RECORDS

The following records were achieved prior to the introduction time limited and over limited games.

16A COMPETITION

<u>BATTING</u>				
Batting Average	K Symonds	Woronora RSL	65/66	120.6
Batting Aggregate	K Hudson	Miranda Magpies	74/75	805
<u>BOWLING</u>				
Bowling Average	P Nelson	Caringbah Sports	60/61	3.3
Bowling Aggregate	M Gardner	Miranda Magpies	70/80	71

16B COMPETITION

<u>BATTING</u>				
Batting Average	J Hart	Sylvania	64/65	105.27
Batting Aggregate	J Hart	Sylvania	64/65	842
<u>BOWLING</u>				
Bowling Average	N Harris	Jannali	74/75	2.93
Bowling Aggregate	A Humphries	Woronora R.S.L.	64/65	74

16C COMPETITION

<u>BATTING</u>				
Batting Average	A Scotti	Boystown	72/73	111.00
Batting Aggregate	G Warne	Sylvania	77/78	609
<u>BOWLING</u>				
Bowling Average	G Hewitt	Jannali	89/90	2.82

12B COMPETITION

<u>BATTING</u>				
Batting Average	C Hill	Cronulla R.S.L.	64/65	140.3
Batting Aggregate	T Young	Cronulla Leagues	81/82	767
<u>BOWLING</u>				
Bowling Average	B Griffin	East Jannali	61/62	2.58
Bowling Aggregate	D Cranston	Engadine	68/69	76

12C COMPETITION

<u>BATTING</u>				
Batting Average	M Flood	Miranda	82/83	178.00
Batting Aggregate	S Edmonds	Taren Point	65/66	548
<u>BOWLING</u>				
Bowling Average	C McAughan	Cronulla R.S.L.	61/62	1.83
Bowling Aggregate	N Fardon	Woronora R.S.L.	67/68	94

12D COMPETITION

<u>BATTING</u>				
Batting Average	G Martin	Como	78/79	100
Batting Aggregate	G Martin	Como	78/79	502
<u>BOWLING</u>				
Bowling Average	S Johnston	Miranda	76/77	1.75
Bowling Aggregate	D Monk	Grays Point	64/65	85

12E COMPETITION

<u>BATTING</u>				
Batting Average	S Geerkens	Como	85/86	86.6
Batting Aggregate	C Parsons	Heathcote	80/81	471
<u>BOWLING</u>				
Bowling Average	S Lawrence	Miranda	76/77	1.75
Bowling Aggregate	S Kellaway	Cronulla R.S.L.	69/70	67

12F COMPETITION

<u>BATTING</u>				
Batting Average	D Morton	Caringbah Sports	85/86	43.25
Batting Aggregate	J Aldridge	Miranda	84/85	229
<u>BOWLING</u>				
Bowling Average	J Chan	Miranda	84/85	2.40
Bowling Aggregate	C Moodie	Engadine	84/85	34

10A COMPETITION

<u>BATTING</u>				
Batting Average	M Carroll	St Patricks	81/82	101
Batting Aggregate	M Condon	Jannali	77/78	766
<u>BOWLING</u>				
Bowling Average	G Hilzinger	Caringbah Sports	59/60	1.6
Bowling Aggregate	W Wishart	Engadine	71/72	83
	D Madley	Miranda	71/72	83

10B COMPETITION

<u>BATTING</u>				
Batting Average	M Souter	Caringbah D.L.S.	85/86	163.00
Batting Aggregate	L Nelson	Caringbah Sports	77/78	520
<u>BOWLING</u>				
Bowling Average	S Mason	Cronulla R.S.L.	62/63	1.40
Bowling Aggregate	D McAlpine	Sylvania	67/68	101

### 16D COMPETITION

#### BATTING

Batting Average	E Zapport	St Patricks	85/86	53.16
Batting Aggregate	P Wilson	Caringbah D.L.S.	86/87	368

#### BOWLING

Bowling Average	D Hunter	St John Bosco	85/86	5.29
Bowling Aggregate	S Dreverman	Sylvania	86/87	45

### 14A COMPETITION

#### BATTING

Batting Average	J Hennessy	Caringbah D.L.S.	82/83	179.25
Batting Aggregate	J Holley	Illawong	87/88	757

#### BOWLING

Bowling Average	G Shrubsole	Miranda	59/60	2.73
Bowling Aggregate	P Keenahan	Miranda	60/61	77

### 14B COMPETITION

#### BATTING

Batting Average	M Graham	Gynea Bay	82/83	294.00
Batting Aggregate	P Fallins	Jannali	77/78	677

#### BOWLING

Bowling Average	E Robinson	Caringbah D.L.S.	61/62	2.23
Bowling Aggregate	M Preddy	St John Bosco	73/74	79

### 14C COMPETITION

#### BATTING

Batting Average	M Molley	Sylvania	82/83	125.60
Batting Aggregate	D Riley	Illawong	80/81	781

#### BOWLING

Bowling Average	L Barrett	Engadine	71/72	2.12
Bowling Aggregate	K Adams	Como	66/67	90

### 14D COMPETITION

#### BATTING

Batting Average	C Cush	Caringbah D.L.S.	89/90	89.60
Batting Aggregate	C Dow	Engadine	76/77	503

#### BOWLING

Bowling Average	G Heath	Caringbah D.L.S.	77/78	2.45
Bowling Aggregate	B Anders	Engadine	74/75	73

### 14E COMPETITION

#### BATTING

Batting Average	A Vial	Gynea Bay	83/84	81.60
Batting Aggregate	D Sharpe	Miranda	80/81	502

#### BOWLING

Bowling Average	M Pink	Heathcote	73/74	2.27
Bowling Aggregate	m Mercer	St Patricks	78/79	55

### 12A COMPETITION

#### BATTING

Batting Average	J Clark	Sylvania	79/80	128.73
Batting Aggregate	A Chellow	Miranda	64/65	637

#### BOWLING

Bowling Average	D Childs	Avoca	60/61	1.80
Bowling Aggregate	G Heffernan	Engadine	75/76	80

### 16A COMPETITION

### "J A DALY SHIELD"

CLUB	W.I.	L.I.	POINTS
Caringbah Sports	10	-	50
Gynea	8	2	42
St Patricks	4	6	26
Engadine	3	7	21
Miranda	2	8	18
Illawong	3	7	17

N.B. Penalty points in this grade

Premiers:	Caringbah Sports		
Batting Average:	M O'Brien	Caringbah Sports	65.0
Batting Aggregate:	C Hockey	Gynea	429
Bowling Average:	D Eaglesham	Gynea	5.61
Bowling Aggregate:	D Eaglesham	Gynea	31
Centuries:	C Hockey	Gynea	168
	D Smith	Miranda	135x
	R Furner	St Patricks	100x
Hat Tricks:	NIL		
Wicket Keepers Award:	T Reynolds	Gynea	
Most catches:	M Turner	Gynea	9

St Patricks took 53 catches

#### BATTING

Association Records:				
Batting Average:	M Smith	Marion	90/91	82.55
Batting Aggregate:	M O'Brien	St John Bosco	90/91	564

PLAYER	CLUB	H.S.	INNS	N.O.	RUNS	AVE
M O'Brien	Caringbah Sports	88	9	4	325	65.0
C Hockey	Gynea	168	11	2	429	47.67
C Lucas	Caringbah Sports	77x	10	2	372	46.5
M Bradley	Caringbah Sports	77	8	0	342	42.75
S Peters	Caringbah Sports	85	10	0	391	39.1
J Skinner	Gynea	52x	11	5	234	39.0
S Gordon	Caringbah Sports	76	9	1	289	36.12
J Abeleven	Caringbah Sports	67	10	0	338	33.8
M Eades	Gynea	57x	9	2	223	31.86
R Furner	St Patricks	100x	9	1	250	31.25
D Smith	Miranda	135x	11	1	298	29.8
C Dickson	Illawong	90	12	0	355	29.58
B Somerville	Engadine	50x	10	2	215	26.88
B Kennis	Illawong	68	11	3	210	26.38
T Brewster	St Patricks	63	10	0	242	24.2

#### BOWLING

Association Records:				
Bowling Average	D Eaglesham	Gynea Bay	92/93	5.61
Bowling Aggregate	D Eaglesham	Gynea Bay	92/93	31

PLAYER	CLUB	OVERS	MONS	WKTS	RUNS	AVE
D Eaglesham	Gynea	91	33	31	174	5.61
W Schofield	Caringbah Sports	65.3	20	18	122	6.78
J Skinner	Gynea	116.2	25	23	214	9.3
C Lucas	Caringbah Sports	77.4	19	11	163	14.82
A Glen	St Patricks	58.4	3	19	293	15.42
J Abeleven	Caringbah Sports	57.1	14	8	128	16.00
M Eades	Gynea	62.3	12	8	133	16.63
A Briggs	Illawong	58.1	6	11	191	17.36
D Shepherd	St Patricks	73.1	11	13	275	21.15
B Kennis	Illawong	65.2	7	9	193	21.44
M O'Brien	Caringbah Sports	61.3	15	6	130	21.67
B Somerville	Engadine	89.3	23	10	218	21.8

C Dickson	Illawong	77.1	9	11	254	23.09
D McCrea	Engadine	103	22	13	303	23.31
S Wilmot	Miranda	99	13	13	305	23.46

FINAL - Caringbah Sports vs Gynea Bay

CARINGBAH SPORTS

BATSMAN	HOW OUT	BOWLER	RUNS
M O'Brien	c Skinner	Eaglesham	91
S Gordon	c Skinner	Grey	2
M Bradley	c Hayward	Grey	4
J Abeleven	c Tracey	Eades	20
S Peters	NOT OUT		10
C Lucas	c W/K Reynolds	Eades	69
J Wever	c Eaglesham	Skinner	0
W Schofield	NOT OUT		3
M Probert			
R Warr			
P Greenacre			
Sundries			

6 for 7  
206

BOWLING	OVERS	MDS	WKTS	RUNS
J Skinner	11	1	1	44
P Grey	12	1	2	33
M Eades	11	1	2	43
C Hockey	5	0	0	19
D Eaglesham	12	1	1	37
S Allam	5	0	0	27

GYMEA BAY

BATSMAN	HOW OUT	BOWLER	RUNS
M Turner	Bowled	Abeleven	16
C Tracey	c W/K Gordon	Lucas	2
M Eades	L.B.W.	Abeleven	2
C Hockey	c Schofield	Lucas	6
T Reynolds	L.B.W.	Abeleven	0
J Skinner	L.B.W.	Lucas	0
S Steyne	stmpd Gordon	Schofield	16
S Allam	c (sub) D Lucas	Aveleven	2
D Eaglesham	NOT OUT		7
A Hayward	c W/K Gordon	Schofield	0
P Grey	Bowled	Bradley	1
Sundries			9

BOWLING	OVERS	MDNS	WKTS	RUNS
J Abeleven	11	2	4	22
C Lucas	11	2	3	14
W Schofield	8	3	2	11
M Bradley	7.1	2	1	9

16B COMPETITION

"LES JOHNSTON TROPHY"

CLUB	W.O.	W.I.	D.	L.I.	L.O.	POINTS
Caringbah Sports	1	8	1	-	-	52
Marion	1	6	-	3	-	41
Caringbah D.L.S.	3	3	-	-	2	41
Cronulla Seagulls	1	6	-	1	2	39
St Patricks	2	1	-	7	-	27
Illawong	-	4	-	3	3	23
Sylvania	2	-	-	7	1	23
St John Bosco	-	1	1	6	2	14

N.B. Penalty Points in this grade

Premiers:	Caringbah Sports		
Batting Average:	G Olson	Cronulla Seagulls	78.75
Batting Aggregate:	P Smith	Marion	362
Bowling Average:	J Catt	Caringbah D.L.S.	6.04
Bowling Aggregate:	J Catt	Caringbah D.L.S.	50
Centuries:	G Olson	Cronulla Seagulls	135x
	D O'Donnell	St Patricks	120x
	M Maguire	St John Bosco	110
	R Badolata	Cronulla Seagulls	104x
	C Jewell	Cronulla Seagulls	103x

Hat Tricks:	NIL		
Wicket Keepers Award:	S Manning	Caringbah Sports	
Most catches:	G Hay	Caringbah Sports	10

Caringbah Sports took 62 catches

BATTING

Association Records:				
Batting Average:	S Welfare	Miranda Magpies	90/91	90.3
Batting Aggregate:	M McLennan	Miranda Magpies	90/91	566

PLAYER	CLUB	H.S.	INNS	N.O.	RUNS	AVE
G Olson	Cronulla Seagulls	135x	6	2	315	78.75
P Smith	Marion	95	12	3	362	40.22
S Manning	Caringbah Sports	83	10	2	316	39.5
T Cadden	Caringbah Sports	71	8	1	263	37.57
D Adams	Caringbah Sports	72	8	0	282	35.25
M Green	Caringbah D.L.S.	48x	15	6	310	34.44
G Bowmer	Caringbah Sports	76	9	0	307	34.11
B Newnham	Caringbah Sports	88	10	1	283	31.44
D O'Donnell	St Patricks	120x	13	1	377	31.42
D Cale	Marion	76	12	2	272	27.2
C Jewell	Cronulla Seagulls	103x	12	1	290	26.36
J Catt	Caringbah D.L.S.	58x	14	4	236	23.6
M Maguire	St John Bosco	110	16	2	325	23.21
W Carroll	Sylvania	63	15	4	211	19.18
S Pounder	Cronulla Seagulls	69	12	1	208	18.91

BOWLING

Association Records:				
Bowling Average	S Welfare	Miranda Magpies	90/91	6.00
Bowling Aggregate	J Catt	Caringbah D.L.S.	92/93	50

PLAYER	CLUB	OVERS	MDNS	WKTS	RUNS	AVE
J Catt	Caringbah D.L.S.	144.4	42	50	302	6.04
B Newnham	Caringbah Sports	61.4	15	18	123	6.83
G Bowmer	Caringbah Sports	90	31	18	128	7.11
S Robertson	Caringbah Sports	128.2	38	32	237	7.41
D Adams	Caringbah Sports	107.1	47	19	147	7.74
G Olson	Cronulla Seagulls	58	23	11	91	8.27
P Hauch	Illawong	95.1	25	23	207	9.0

M Maguire	St John Bosco	102.1	22	27	254	9.41
T Calderwood	St Patricks	64.4	22	14	140	10.0
S Pounder	Cronulla Seagulls	127.4	23	34	341	10.03
M Green	Caringbah D.L.S.	84.5	13	24	242	10.08
A Simpson	Illawong	70	17	18	212	11.78
D Knight	Illawong	85	20	23	277	12.04
J Purdy	Marion	106.1	27	17	206	12.12
M Garvan	Marion	105	21	22	276	12.55

FINAL - Caringbah Sports vs Marion

CARINGBAH SPORTS

BATSMAN	HOW OUT	BOWLER	RUNS
B Newnham	c Smith	Cale	17
G Hay	c W/K	Garvan	6
D Adams	c Purdy	Purdy	6
G Bowmer	c Merrill	Darlow	9
T Cadden	c Merrill	Darlow	5
S Manning	c Garvan	Darlow	2
S Robertson	c Roper	Smith	9
M Gleeson	NOT OUT		11
E Yates	c W/K	Darlow	4
S Milsted	Bowled	Cale	3
B Griffiths	c Cale	Purdy	0
Sundries			18
		All out for	90

BOWLING	OVERS	MDS	WKTS	RUNS
D Cale	9	1	2	14
N Garvan	10	1	1	24
J Purdy	7.3	3	2	14
T Darlow	12	5	4	14
P Smith	6	0	1	19
Sundries				5

MARTON

BATSMAN	HOW OUT	BOWLER	RUNS
N Barry	Bowled	Adams	1
D Cale	Bowled	Newnham	6
P Smith	Bowled	Adams	0
B May	c Bowmer	Newnham	1
M Garvan	c Milsted	Newnham	5
S Mozsey	Bowled	Adams	0
M Beyer	c W/K Manning	Newnham	2
N Roper	Bowled	Adams	0
J Purdy	NOT OUT		18
T Darlow	c Bowmer	Cadden	16
S Merrill	Bowled	Cadden	2
Sundries			14
			65

BOWLING	OVERS	MDNS	WKTS	RUNS
D Adams	12	5	4	11
B Newnham	12	5	4	10
S Robertson	12	8	0	12
G Bowmer	12	7	0	15
M Gleeson	4	1	0	4
T Cadden	5	1	2	10

Caringbah Sports won by 25 runs

14A COMPETITION

"ARTHUR BOMBELL TROPHY"

CLUB	W.O.	W.L.	D.	L.L.	L.O.	POINTS
Engadine Dragons	1	7	-	2	-	44
Caringbah Sports	1	6	-	2	1	40
Gynea Bay	1	4	1	4	-	35
Como Jannali	-	6	-	4	-	34
Illawong	-	2	1	7	-	20
Miranda Magpies	-	1	-	7	2	11

N.B. Penalty Points in this grade

Premiers:	Caringbah Sports
Minor Premiers:	Engadine
Batting Average:	C Lake
Batting Aggregate:	C Lake
Bowling Average:	N Ward
Bowling Aggregate:	N Ward
	A Davis
	C Lake
Centuries:	C Lake
	B Ronald
	C Brownescombe
	B Wicks
	A Brodbeck
Hat Tricks:	NIL
Wicket Keepers Award:	R Brewster
Most catches:	D Godkin

Caringbah Sports took 65 catches

BATTING

Association Records:				
Batting Average:	J Abeleven	Caringbah Sports	90/91	73.5
Batting Aggregate:	C Lake	Engadine	92/93	643

PLAYER	CLUB	H.S.	INNS	N.O.	RUNS	AVE
C Lake	Engadine	159	10	1	643	71.44
B Wicks	Como Jannali	126x	11	3	435	54.38
C Brownescombe	Engadine	128	10	1	408	45.33
B Ronald	Illawong	142	9	0	404	44.89
A Brodbeck	Caringbah Sports	101R	9	1	265	33.13
D Godkin	Caringbah Sports	87x	10	2	256	32.00
M Uebel	Gynea	57	8	1	213	30.43
R Brewster	Como Jannali	98	11	1	290	29.00
A Brennan	Gynea	51	9	0	242	26.89
N Ward	Caringbah Sports	39	9	1	215	26.88

BOWLING

Association Records:				
Bowling Average	J Skinner	Gynea Bay	90/91	6.00
Bowling Aggregate	W Schofield	Caringbah Sports	89/90	35

PLAYER	CLUB	OVERS	MDNS	WKTS	RUNS	AVE
N Ward	Caringbah Sports	62.4	12	19	171	9.0
C Lake	Engadine	98.5	25	19	175	9.21
D Godkin	Caringbah Sports	87	28	15	152	10.13
M Skillicorn	Gynea	66	18	11	114	10.36
A Davis	Como Jannali	106.4	36	19	215	11.32
A Brodbeck	Caringbah Sports	99	20	16	195	12.19
H Singadia	Caringbah Sports	105	33	14	171	12.21
B Gorrey	Engadine	64	11	13	163	12.54
S Carlisle	Engadine	106	27	16	212	13.25
C Thomas	Como Jannali	105.2	23	17	238	14.0
C Brownescombe	Engadine	93.2	34	11	164	14.91
M Heffernan	Miranda	108.5	24	17	255	15.0

D Lee	Illawong	68	11	12	202	16.83
C Macnamara	Gymea	66.2	13	9	153	17.0
B Colman	Como Jannali	68	19	8	144	18.0

FINAL - Caringbah Sports vs Engadine

CARINGBAH SPORTS

BATSMAN	HOW OUT	BOWLER	RUNS
N Ward	c Lake	Carlisle	0
P Myers	c Wilson	Lake	19
S Rooney	c Slack	Wilson	11
A Brodbeck	c McIntyre	Wilson	22
D Godkin	Bowled	Brownscombe	49
C Best	L.B.W.	Lake	2
D Masters	RUN OUT		24
B Cameron	Bowled	Brownscombe	0
W Jacobs	NOT OUT		4
N Davies	NOT OUT		1
H Singadia			
Sundries			12
		6 for	144

BOWLING	OVERS	MDS	WKTS	RUNS
S Carlisle	12	0	1	41
C Brownscombe	12	3	2	29
M Eades	11	1	2	43
L Wilson	12	3	2	21
D Hockey	5	0	0	23
C Lake	12	8	2	7
B Gorrey	6	0	0	20

ENGADINE

BATSMAN	HOW OUT	BOWLER	RUNS
C Lake	Bowled	Masters	29
P McIntyre	Bowled	Singadia	3
C Brownscombe	c Brodbeck	Masters	4
C Mallinson	Bowled	Masters	16
A Palmer	Bowled	Masters	0
B Gorrey	c Brodbeck	Godkin	4
S Slack	c Brodbeck	Masters	0
L Wilson	Bowled	Brodbeck	6
B England	Bowled	Masters	0
S Carlisle	NOT OUT		5
D Hockey	c Godkin	Masters	0
Sundries			5
		All out	72

BOWLING	OVERS	MDS	WKTS	RUNS
A Brodbeck	8	3	2	9
H Singadia	12	4	1	18
C Best	3	0	0	17
D Masters	12	6	7	15
D Godkin	10	5	1	11

Caringbah Sports won by 72 runs

14B COMPETITION

"JOHN MOODIE SHIELD"

CLUB	W.O.	W.I.	L.I.	L.O.	POINTS
St Patricks	1	8	1	-	49
Sylvania	1	8	1	-	49
Illawong (2)	1	4	5	-	33
Illawong (1)	2	1	6	1	27
Caringbah D.L.S.	-	4	6	-	26
Cronulla Seagulls	-	-	6	4	6

Premiers:	St Patricks		
Minor Premiers:	Sylvania		
Batting Average:	T Cuthill	Sylvania	75.33
Batting Aggregate:	S Hair	St Patricks	469
Bowling Average:	C Kuveju	Sylvania	7.5
Bowling Aggregate:	C Kuveju	Sylvania	18
Centuries:	T Cuthill	Sylvania	125
	N Swain	Illawong (2)	114x
Hat Tricks:	NIL		
Wicket Keepers Award:	S Hair	St Patricks	
Most catches:	D O'Shea	Cronulla Seagulls	8
	J Watkins	Sylvania	8

Sylvania took 51 catches

BATTING

Association Records:				
Batting Average:	T Cuthill	Sylvania	92/93	75.33
Batting Aggregate:	S Hair	St Patricks	92/93	469

PLAYER	CLUB	H.S.	INNS	N.O.	RUNS	AVE
T Cuthill	Sylvania	125	9	3	452	75.33
S Hair	St Patricks	86	10	2	469	58.63
N Davis	Sylvania	61x	9	3	338	56.33
T Fenech	St Patricks	98x	10	4	329	54.83
L Fleming	Caringbah D.L.S.	73	12	0	377	31.42
B Pilgrim	Illawong (2)	89x	12	4	226	28.25
A Reid	Illawong (2)	72	12	2	243	24.3
N Swain	Illawong (2)	114x	13	2	265	24.09
T Power	Illawong (1)	77x	12	3	210	23.33
S Pisani	Caringbah D.L.S.	50	12	0	253	21.08
D O'Shea	Cronulla Seagulls	66x	16	1	285	19.0
D Roast	Cronulla Seagulls	53x	17	3	224	16.0

BOWLING

Association Records:				
Bowling Average	G Nair	St John Bosco	89/90	4.32
Bowling Aggregate	G Nair	St John Bosco	89/90	34

PLAYER	CLUB	OVERS	MDS	WKTS	RUNS	AVE
C Kuveju	Sylvania	77	23	18	135	7.5
D Hunter	St Patricks	72	19	17	134	7.88
T Fenech	St Patricks	58	17	14	124	8.86
A Moss	Illawong (1)	55	11	13	125	9.62
M Keep	St Patricks	69	22	14	150	10.71
C Moran	St Patricks	78.1	20	13	145	11.15
D Freeland	Illawong (2)	82	14	15	211	14.07
R Mitchell	Sylvania	87.5	16	13	222	17.07
S Vickery	Illawong (1)	65	16	8	145	18.13
P Moran	St Patricks	59.1	7	10	206	20.6
A Reid	Illawong (2)	72	16	9	191	21.22
A Wilmot	Caringbah D.L.S.	71	8	10	221	22.1
D Roast	Cronulla Seagulls	79	6	12	276	23.0
A Gibson	Cronulla Seagulls	70	6	11	267	24.27
D O'Shea	Cronulla Seagulls	105	17	11	268	24.36
L Fleming	Caringbah D.L.S.	84	23	8	204	25.5

FINAL - St Patricks vs Sylvania

ST PATRICKS

BATSMAN	HOW OUT	BOWLER	RUNS
S McEvoy	RUN OUT		12
A O'Neill	c Lock	Taniane	4
S Hair	c Davis	Sundram	42
T Fenech	c Davis	Kuveju	11
M Keep	c Davis	Riley	0
D Hunter	Bowled	Kuveju	4
R Fenech	Bowled	Mitchell	21
J McInerney	c Davis	Sundram	13
P Moran	Bowled	Sundram	3
G Robeson	c Jobson	Sundram	0
C Moran	NOT OUT		0
Sundries			31

All out 141

BOWLING	OVERS	MDS	WKTS	RUNS
C Kuveju	10	2	2	31
P Taniane	10	1	1	21
R Mitchell	10	1	1	14
G Emerton	2	0	0	6
G Riley	10	1	1	32
R Sundram	7	2	4	13
R Cuthill	1	0	0	3

SYLVANIA

BATSMAN	HOW OUT	BOWLER	RUNS
G Emerton	Bowled	McEvoy	9
N Davis	L.B.W.	McEvoy	1
P Taniane	Bowled		13
T Cuthill	Bowled	C Moran	2
R Sundram	c Hair	C Moran	0
T Collins	Bowled	Keep	1
R Mitchell	c Keep	McEvoy	0
S Jobson	Bowled	Hunter	16
C Kuveju	Bowled	Keep	0
G Riley	c P Moran	T Fenech	3
S Locke	NOT OUT		10
Sundries			16

71

BOWLING	OVERS	MDS	WKTS	RUNS
C Moran	10	6	2	6
G Robeson	6	2	0	8
S McEvoy	10	5	3	15
M Keep	10	4	2	14
T Fenech	6	2	1	9
D Hunter	3	0	1	14

St Patricks won by 70 runs

14C COMPETITION

"TIM WALKER TROPHY"

CLUB	W.O.	W.I.	BYE	L.I.	L.O.	POINTS
Gynea	-	9	1	-	-	50
Caringbah Sports	1	5	2	2	-	45
St Patricks	-	5	1	4	-	34
Engadine	-	4	2	4	-	34
Sylvania	-	4	1	5	-	30
Illawong	-	1	2	6	1	21

Premiers:	Caringbah Sports
Minor Premiers:	Gynea
Batting Average:	M Paull Caringbah Sports 60.4
Batting Aggregate:	R Forshaw Sylvania 398
Bowling Average:	T Gow Illawong 5.84
Bowling Aggregate:	T Gow Illawong 25
Centuries:	R Forshaw Sylvania 110x
	G Price Engadine 103x
	J Littman Gynea 100x
Hat Tricks:	NIL
Wicket Keepers Award:	D Wackwitz Engadine
Most catches:	G Hull Como Jannali 9

Como Jannali & St Patricks took 41 catches

BATTING

Association Records:				
Batting Average:	M Paull	Caringbah Sports	92/93	60.4
Batting Aggregate:	D Sydes	St John Bosco	91/92	477

PLAYER	CLUB	H.S.	INNS	N.O.	RUNS	AVE
M Paull	Caringbah Sports	76	8	3	302	60.4
R Forshaw	Sylvania	110x	9	2	398	56.86
J Littman	Gynea	100x	9	5	191	47.75
A Gordon	Caringbah Sports	82	7	0	272	38.86
D Baker	Gynea	94	8	0	310	38.75
J Gleeson	Caringbah Sports	78	7	0	240	34.29
D Wackwitz	Engadine	68x	8	1	182	26.0
D Gough	Como Jannali	69	11	1	217	21.7

BOWLING

Association Records:				
Bowling Average	M Kerr	Caringbah Sports	89/90	4.60
Bowling Aggregate	H Singadia	Caringbah Sports	91/92	27

PLAYER	CLUB	OVERS	MDS	WKTS	RUNS	AVE
T Gow	Illawong	78.2	27	25	146	5.84
B Clifford	Caringbah Sports	52.2	12	16	112	7.00
M Paull	Caringbah Sports	65.1	15	15	129	8.6
J Davis	Caringbah Sports	64.3	14	11	100	9.09
Joel Cooper	St Patricks	76.5	20	20	192	9.6
T Bonnitcha	Engadine	69	20	11	114	10.36
A Bevan	Engadine	55.3	13	12	127	10.58
S Cummins	Caringbah Sports	51.2	9	11	123	11.18
D Owen	Gynea	51	8	7	84	12.0
M Clark	Gynea	59	23	9	112	12.44
R Kennedy	Gynea	60	6	12	160	13.33
M Sutton	Gynea	58	16	8	111	13.88
G Solomon	Illawong	62.4	7	14	206	14.71
M Wylie	Sylvania	61.4	7	9	181	20.11
G Scott	Engadine	58	13	8	165	20.63

FINAL - Caringbah Sports vs Gynea Bay

CARINGBAH

BATSMAN	HOW OUT	BOWLER	RUNS
A Gordon	c Blacker	Clark	12
M Paull	Bowled	Sutton	18
T Cunnings	c Sutton	Kennedy	2
J Gleeson	Bowled	Kennedy	4
J Davis	c W/K Bradbury	Kennedy	0
S Cummins	L.B.W.	Sutton	9
S Greenacre	NOT OUT		37
C Laing	RUN OUT		7
B Clifford	c Sutton	Baker	4
M Salvetti	NOT OUT		10
K J'Rourke			
Sundries			12
		8 for	115

BOWLING	OVERS	MDNS	WKTS	RUNS
D Owen	10	1	0	17
M Clark	10	2	1	23
M Sutton	10	4	2	15
R Kennedy	9	1	3	38
D Baker	5.1	0	1	21

GYNEA

BATSMAN	HOW OUT	BOWLER	RUNS
D Baker	c Greenacre	Paull	6
M Sutton	c Clifford	Greenacre	3
M Clark	c Salvetti	Clifford	46
P McInnes	Bowled	Paull	4
N Hughes	c Salvetti	Clifford	5
J Littman	Bowled	Clifford	0
G Elacker	L.B.W.	Cummins	4
D Owen	NOT OUT		11
G Bradbury	c Clifford	Cummins	0
R Kennedy	stmp Gordon	Cunnings	2
W McKinley	Bowled	Greenacre	0
Sundries			32
		All out	113

BOWLING	OVERS	MDNS	WKTS	RUNS
S Cummins	10	0	2	27
S Greenacre	6.2	1	2	8
J Davis	5	0	0	8
M Paull	4	1	2	12
B Clifford	10	1	3	22
C Laing	7	1	0	23
T Cunnings	2	0	1	5

Caringbah Sports won by 2 wickets

140 COMPETITION

"GORDON THOMSON TROPHY"

CLUB	W.O.	W.I.	L.I.	L.O.	D.	POINTS
Miranda Magpies	2	4	4	-	-	40
Caringbah Sports	-	7	3	-	-	38
Gynea	1	7	2	-	-	37
St John Bosco	1	3	5	-	1	31
St Patricks	-	2	6	2	-	16
Illawong	-	2	6	2	-	14

N.B. Penalty points in this grade.

Premiers:	Miranda Magpies		
Batting Average:	J Mulcair	Gynea	37.17
Batting Aggregate:	M Wallis	St Patricks	292
Bowling Average:	A Fryz	Miranda	7.52
Bowling Aggregate:	J Fielding	Miranda	23
Centuries:	NIL		
Hat Tricks:	M Hall	Caringbah Sports	1
	R Daniels	St John Bosco	1
Wicket Keepers Award:	S Murray	Gynea	
Most catches:	J Fielding	Miranda	13
	Gynea took 46 catches		

BATTING

Association Records:				
Batting Average:	D Shepherd	Grays Point	90/91	48.2
Batting Aggregate:	M Maguire	St John Bosco	90/91	343

PLAYER	CLUB	H.S.	INNS	N.O.	RUNS	AVE
J Mulcair	Gynea	58x	8	2	223	37.17
M Wallis	St Patricks	51	15	7	292	36.5
W Oates	Caringbah Sports	70	8	1	232	33.14
M Edwards	Miranda	53x	9	1	201	25.13
S Bracht	Illawong	47	12	2	246	24.6
A Parkinson	Illawong	41x	16	6	222	22.2
A Bradley	Illawong	52	15	2	204	15.69

BOWLING

Association Records:				
Bowling Average	C Armour	Illawong	90/91	5.00
Bowling Aggregate	C Armour	Illawong	90/91	34

PLAYER	CLUB	OVERS	MDNS	WKTS	RUNS	AVE
A Fryz	Miranda	64.1	9	21	158	7.52
J Mulcair	Gynea	72.2	13	22	179	8.14
J Fielding	Miranda	84.5	11	23	202	8.78
A Phipps	Gynea	67	12	19	171	9.0
D Vandenberg	St John Bosco	94.3	15	20	215	10.75
R Wills	Caringbah Sports	85	14	21	226	10.76
B Cook	Caringbah Sports	77	22	13	155	11.92
G Hawley	Gynea	78	13	12	173	14.42
S Nathwani	St John Bosco	89.4	15	15	223	14.87
R Vandenberg	St John Bosco	69.1	8	16	238	14.88
M Wallis	St Patricks	83.3	18	13	205	15.77
S Wallis	St John Bosco	63	10	12	214	17.83



FINAL - Miranda vs Caringbah Sports

MIRANDA

BATSMAN	HOW OUT	BOWLER	RUNS
B Mitchell	c Baglin	Ziems	8
G Carr	NOT OUT		36
A Warry	c W/K Philip	Bowmer	16
M Edwards	RUN OUT		2
J Fielding	NOT OUT		8
A Macdessi			
A Frytz			
N Gale			
P Keane			
R Duggan			
K Coles			
Sundries			23
	3 for		93

BOWLING	OVERS	MDIS	WKTS	RUNS
R Wills	8	3	0	6
B Cook	8	3	0	20
M Hall	3	1	0	3
M Ziems	3	0	1	8
C Rummy	4	0	0	13
W Oates	4	1	0	9
A Lumb	3	0	0	6
S Bowmer	3	0	1	8
S Smyth	1	0	0	5
L Philip	1	0	0	8

CARINGBAH SPORTS

BATSMAN	HOW OUT	BOWLER	RUNS
W Oates	RUN OUT		5
C Rummy	Bowled	Frytz	5
M Ziems	Bowled	Fielding	6
A Lumb	Bowled	Duggan	1
L Philip	Bowled	Duggan	2
B Cook	c Frytz	Fielding	1
M Hall	c Fielding	Fielding	5
R Wills	c W/K Carr	Frytz	5
S Bowmer	Bowled	Frytz	16
S Smyth	Bowled	Warry	0
M Davis	NOT OUT		1
Sundries			15
	All out		62

BOWLING	OVERS	MDIS	WKTS	RUNS
A Warry	7	0	1	16
A Frytz	9	2	3	12
J Fielding	10	3	3	10
R Duggan	9	0	2	15
B Mitchell	1	0	0	6

Miranda won by 7 wickets

# Sorry! we don't mean to HOG all the business



... "IT'S JUST THAT WE ARE SO GOOD AT THE CRICKET BUSINESS"

\* PRICES UNMATCHED IN THE CRICKET TRADE

\* A GENUINE DESIRE TO GIVE YOU SERVICE

\* REPAIRS AND ADVICE ON PRODUCTS

\* THE LARGEST SELECTION OF CRICKET EQUIPMENT UNDER ONE ROOF

ALL AT DISCOUNTED CLUB PRICES!

## KINGSGROVE SPORTS CENTRE

247-249 Kingsgrove Road, KINGSGROVE, NSW, 2208

Phone (02) 50 87775, 502 1174

PHONE IN OR WRITE FOR OUR SUPER MAIL ORDER COLOUR CATALOGUE

## 12A COMPETITION

## "TED SYKES TROPHY, INC. ALLAN FALLIN SHIELD"

CLB	W.O.	W.I.	L.I.	L.O.	POINTS
Illawong	2	5	3	-	44
Sylvania	-	8	2	-	42
Caringbah Sports	1	4	5	-	36
Engadine	1	4	5	-	33
Gymea	2	2	4	2	30
Como Jannali	1	3	6	-	29

N.B. Penalty points lost this grade.

Premiers:	Sylvania			
Minor Premiers:	Illawong			
Batting Average:	G Harris	Sylvania	113.25	
Batting Aggregate:	G Harris	Sylvania	453	
Bowling Average:	S McGeachie	Illawong	6.44	
Bowling Aggregate:	S McGeachie	Illawong	34	
Centuries:	D Lucas	Caringbah Sports	112	
	K Stewart	Engadine	101x	
Hat Tricks:	NIL			
Wicket Keepers Award:	D Mitchell	Como Jannali		
Most catches:	D Lucas	Caringbah Sports	12	

Engadine took 57 catches

## BATTING

Association Records:				
Batting Average:	G Harris	Sylvania	92/93	113.25
Batting Aggregate:	C Lake	Engadine	90/91	576

PLAYER	CLUB	H.S.	INNS	N.O.	RUNS	AVE
G Harris	Sylvania	98x	9	5	453	113.25
D Lucas	Caringbah Sports	112	10	2	368	46.00
S McGeachie	Illawong	95	11	1	420	42.00
Rod Stafford	Sylvania	71x	11	2	315	35.00
K Stewart	Engadine	101x	11	2	265	29.44

## BOWLING

Association Records:				
Bowling Average:	D Tozer	Como Jannali	90/91	6.20
Bowling Aggregate:	A Davis	Como Jannali	91/92	36

PLAYER	CLUB	OVERS	MDNS	WKTS	RUNS	AVE
S McGeachie	Illawong	134	39	34	219	6.44
D Rowland	Caringbah Sports	67.3	14	16	116	7.25
C Beattie	Gymea	67	14	18	139	7.72
B Routh	Illawong	98.1	20	21	178	8.47
K Stewart	Engadine	95	30	18	158	8.77
M Woods	Caringbah Sports	71	12	15	133	8.86
S Cowley	Sylvania	107	30	19	191	10.05
J Mils	Como Jannali	110	28	17	190	11.17
M Gore	Engadine	78	18	18	204	11.33
M Peters	Caringbah Sports	132.3	27	21	253	12.04
G Harris	Sylvania	110.5	31	18	230	12.77
R Sowron	Como Jannali	79.2	14	14	180	12.85
D Lucas	Caringbah Sports	135.4	22	22	287	13.04
J McInnes	Gymea	99	17	19	260	13.63
T Glennan	Engadine	69	20	9	125	13.88
C Hill	Como Jannali	92.4	12	16	223	13.93

## FINAL - Sylvania vs Como Jannali

## SYLVANIA

BATSMAN	HOW OUT	BOWLER	RUNS
G Harris	RUN OUT		43
S Laws	Bowled	McGeachie	0
R Cowley	c Routh	Padt	15
S Rod Stafford	c McGeachie	Myers	0
M Culkoff	NOT OUT		62
C Marvin	c Fitzgibbon	Allen	0
T Fleming	c Kennis	Padt	13
D Croucher	RUN OUT		8
D Burns	NOT OUT		0
Richard Stafford			
A Bedi			
Sundries			13
		7 for	154

BOWLING	OVERS	MDS	WKTS	RUNS
S McGeachie	12	3	1	21
B Routh	12	1	0	28
A Padt	12	0	2	35
A Myers	12	1	1	32
A Arnold	4	0	0	9
P Fitzgibbon	5	0	0	13
S Allen	3	0	1	13

## ILLAWONG

BATSMAN	HOW OUT	BOWLER	RUNS
S Allen	Bowled	Laws	4
A Padt	Bowled	Laws	1
S McGeachie	c Fleming	Harris	74
A Myers	c Rod Stafford	Laws	4
R Ragel	c Culkoff	Fleming	11
B Routh	c Marvin	Fleming	3
T Leedham	RUN OUT		11
P Fitzgibbon	RUN OUT		1
C Kennis	c Rod Stafford	Harris	2
C Bowman	RUN OUT		1
A Arnold	NOT OUT		1
Sundries			15
		All out for	128

BOWLING	OVERS	MDNS	WKTS	RUNS
S Cowley	12	3	0	30
G Harris	11.5	2	2	30
S Laws	8	3	3	11
M Culkoff	9	1	0	23
Rod Stafford	7	1	0	16
T Fleming	8	3	2	14

Como won by 3 wickets

## 12B COMPETITION

## "MAL HENDERSON TROPHY"

CLUB	W.O.	W.l.	D.	L.O.	L.l.	POINTS
Caringbah Sports	1	9	-	-	-	53
Illawong	1	4	1	2	2	33
Sylvania	-	4	-	-	6	26
Como Jannali	-	3	-	1	6	21
Gynea	-	2	1	1	6	19
St Patricks	1	-	-	3	6	14

Premiers:	Caringbah Sports				
Batting Average:	P Cox	Gynea	51.00		
Batting Aggregate:	M Perrett	Illawong	382		
Bowling Average:	R Wellington	Illawong	4.33		
Bowling Aggregate:	A Hubbard	Caringbah Sports	26		
	J Hunter	St Patricks	26		
Centuries:	P Cox	Gynea	117		
	J Whitehall	Sylvania	108		
Hat Tricks:	NIL				
Wicket Keepers Award:	NIL				
Most catches:	B Pinney	Caringbah Sports	12		
Caringbah Sports took 46 catches					

## BATTING

Association Records:					
Batting Average:	D Cox	Miranda Magpies	90/91	61.83	
Batting Aggregate:	B Wicks	Como Jannali	90/91	490	

PLAYER	CLUB	H.S.	INNS	N.O.	RUNS	AVE
P Cox	Gynea	117	8	1	357	51.00
M Perrett	Illawong	73x	15	7	382	47.75
T Fisher	Caringbah Sports	50x	8	3	204	40.80
A Hubbard	Caringbah Sports	88	8	1	277	39.50
J Whitehall	Sylvania	108	13	0	296	22.79
S Owen	Como Jannali	56x	13	3	211	21.10
J Hunter	St Patricks	49	16	1	281	18.73
G Morriss	St Patricks	37	14	3	201	16.75
A Fuller	Illawong	66	14	1	216	16.61
R Wellington	Illawong	49	15	1	218	15.57

## BOWLING

Association Records:					
Bowling Average	R Wellington	Illawong	92/93	4.33	
Bowling Aggregate	T Fenech	St Patricks	91/92	38	

PLAYER	CLUB	OVERS	MDNS	WKTS	RUNS	AVE
R Wellington	Illawong	65	14	12	52	4.33
T Fisher	Caringbah Sports	80	24	24	131	5.45
A Hubbard	Caringbah Sports	74	12	26	154	5.92
J Hunter	St Patricks	112	38	26	189	7.26
B Pinney	Caringbah Sports	85	25	15	128	8.53
A DeGruiter	Como Jannali	78	14	10	94	9.40
M Perrett	Illawong	71.2	20	14	147	10.50
G Morriss	St Patricks	111	30	19	213	11.21
B Anderson	Sylvania	56.5	10	17	204	12.00
M Hadfield	Gynea	65	14	9	139	15.44
P Conway	Como Jannali	56	7	10	192	19.20
A Robinson	Sylvania	75	9	9	173	19.22
M Ferguson	Sylvania	73	12	11	215	19.54

## FINAL - Caringbah Sports vs Illawong

## CARINGBAH SPORTS

BATSMAN	HOW OUT	BOWLER	RUNS
A Hubbard	c McKinnon	Power	13
S Hall	Bowled	Fuller	6
B Pinney	c Power	Wellington	7
T Fisher	NOT OUT		18
S Hardcastle	NOT OUT		6
M Berringer			
J Barrett Lennard			
S Godfrey			
H Blows			
A Pallister			
C Harvey			
Sundries			
			19
3 for			69

BOWLING	OVERS	MDS	WKTS	RUNS
M Perrett	10	6	0	11
R Wellington	10	4	1	12
M Power	10	2	1	13
A Fuller	10	4	1	8
M Stiles	2	1	0	2
D Moss	1	0	0	5
R Halloran	2	1	0	3
R McKinnon	1	0	0	2
A Gale	1	0	0	3
C Smith	1	0	0	2

## ILLAWONG

BATSMAN	HOW OUT	BOWLER	RUNS
M Power	c Fisher	Hubbard	2
A Fuller	Bowled	Pinney	0
M Perrett	c Barrett Lennard	Berringer	11
C Smith	Bowled	Hubbard	2
R Wellington	c Pallister	Fisher	9
R McKinnon	c Fisher	Godfrey	13
B Waygood	c Pallister	Berringer	0
D Moss	c Pallister	Fisher	8
A Gale	c Hardcastle	Hardcastle	4
M Stiles	c Pinney	Fisher	0
M Halloran	NOT OUT		0
Sundries			9
			All out
			58

BOWLING	OVERS	MDNS	WKTS	RUNS
A Hubbard	7	1	2	10
B Pinney	7	0	1	17
T Fisher	6.2	1	3	9
M Berringer	7	1	2	15
S Hardcastle	6	4	1	2
S Godfrey	2	0	1	4

Caringbah Sports won by 7 wickets

## 12C COMPETITION

## "TYNAN MOTORS TROPHY"

CLUB	W.O.	W.L.	D.	TIE	L.O.	L.I.	POINTS
Caringbah Sports	1	8	-	-	-	1	49
Miranda	3	4	1	-	-	2	49
St John Bosco	2	5	1	1	-	1	40
Illawong	1	2	-	-	-	7	24
Heathcote	1	1	-	1	-	7	23
Como Jannali	-	4	-	-	2	4	19

N.B. Penalty points lost this grade.

Premiers:	Miranda			
Minor Premiers:	Caringbah Sports			
Batting Average:	D Mapstone	Caringbah Sports	46.75	
Batting Aggregate:	G Dumbrell	St John Bosco	233	
Bowling Average:	L Ireland	Caringbah Sports	4.86	
Bowling Aggregate:	G Dumbrell	St John Bosco	29	
Centuries:	NIL			
Hat Tricks:	L Foskett	Caringbah Sports	1 (In Final)	
Wicket Keepers Award:	B Percey	Illawong		
Most catches:	T Dalforno	St John Bosco	13	
	Illawong took 60 catches			

## BATTING

Association Records:				
Batting Average:	D Sweeney	Grays Point	90/91	74.20
Batting Aggregate:	S Pisani	Cronulla Seagulls	90/91	430

PLAYER	CLUB	H.S.	INNS	N.O.	RUNS	AVE
D Mapstone	Caringbah Sports	70x	9	5	187	46.75
G Dumbrell	St John Bosco	66	11	4	233	33.28
L Ireland	Caringbah Sports	74	9	0	183	20.33
M Tiley	Heathcote	39x	11	4	165	23.57
B Percey	Illawong	57x	11	2	202	22.44
P Johnston	Miranda	49	9	0	201	22.33
D Vormister	Heathcote	50	10	3	153	21.85
S Allison	Miranda	75x	9	3	145	20.75
D Gurney	St John Bosco	53	10	2	154	19.25
A Allison	Miranda	94	9	0	168	18.66
J Tierney	Como Jannali	69	13	1	224	18.66

## BOWLING

Association Records:				
Bowling Average	M Gleeson	Caringbah Sports	89/90	2.03
Bowling Aggregate	K Stewart	Engadine	91/92	30

PLAYER	CLUB	OVERS	MDNS	WKTS	RUNS	AVE
L Ireland	Caringbah Sports	70.4	18	22	107	4.86
G Dumbrell	St John Bosco	88.5	28	29	142	4.89
A Dyson	Miranda	55.2	7	22	115	5.22
M Tiley	Heathcote	75.3	15	23	128	5.56
D Gurney	St John Bosco	69	11	23	134	5.82
P Johnston	Miranda	57	20	13	78	6.00
D Mapstone	Caringbah Sports	61	17	17	104	6.12
S Allison	Miranda	60	12	16	104	6.5
A Allison	Miranda	54	14	12	83	6.91
D Smith	Illawong	48	8	19	129	6.78
M Seeto	Miranda	42	10	12	90	7.50
J Eyres	Como Jannali	46	2	15	136	9.06
S Gallagher	Como Jannali	42	5	11	100	9.09
C McArthur	Illawong	74	13	18	166	9.22
N Friend	Heathcote	38	3	10	97	9.70

## FINAL - Caringbah Sports vs Miranda

## MIRANDA

BATSMAN	HOW OUT	BOWLER	RUNS
A Dyson	Bowled	Mapstone	4
M Seeto	c Ireland	Foskett	14
P Johnston	c Mapstone	Moffitt	9
A Allison	c McKenzie	Foskett	31
S Allison	NOT OUT		17
A Houston	c Ireland	Foskett	0
R Ovens	Bowled	Foskett	0
S Davies	Bowled	Ireland	1
T Reynolds	Bowled	Mapstone	0
M Penning	RUN OUT		3
C Doel			
Sandries			24
			9 for 103

BOWLING	OVERS	MDS	WKTS	RUNS
L Ireland	10	2	1	14
D Mapstone	10	3	2	11
B McKenzie	10	4	0	9
D Moffitt	8	0	1	35
N Hughston	5	0	0	14
L Foskett (inc Hat Trick)	6	0	4	12
T Sempel	1	0	0	6

## CARINGBAH SPORTS

BATSMAN	HOW OUT	BOWLER	RUNS
T Sempel	RUN OUT		0
M Reid	Bowled	Ovens	12
L Foskett	Bowled	A Allison	0
L Ireland	c A Allison	Johnston	3
B McKenzie	Bowled	A Allison	2
J Smithurst	RUN OUT		0
D Mapstone	Bowled	A Allison	12
C Pacey	NOT OUT		27
N Hughston	L.B.W.	Dyson	7
D Moffitt	RUN OUT		4
A Fisher			
Sandries			26
			8 for 93

BOWLING	OVERS	MDNS	WKTS	RUNS
P Johnston	10	2	1	14
A Allison	10	5	3	8
S Allison	10	3	0	16
R Ovens	6	0	1	21
A Dyson	9	0	1	24
A Houston	5	0	0	8

Miranda won by 10 runs

## 12D COMPETITION

## "DON DOBIE TROPHY"

CLUB	W.L.	L.O.	L.I.	POINTS
Como Jannali	8	-	2	42
Sylvania	7	-	3	38
Miranda	4	-	6	19
Engadine	2	-	8	18
Cronulla Seagulls	3	3	4	18
Gynea	1	1	8	13

N.B. Penalty points lost this grade.

Premiers:	Como Jannali			
Batting Average:	A Houston	Miranda	68.5	
Batting Aggregate:	A Houston	Miranda	274	
Bowling Average:	E Langham	Como Jannali	4.35	
Bowling Aggregate:	M Doyon	Sylvania	22	
Centuries:	NIL			
Hat Tricks:	D McGill	Sylvania	1	
Wicket Keepers Award:	T Butterworth	Gynea		
Most catches:	B Jewell	Cronulla Seagulls	11	
Como Jannali & Sylvania took 44 catches				

## BATTING

Association Records:				
Batting Average:	A Houston	Miranda	92/93	68.5
Batting Aggregate:	A Houston	Miranda	92/93	274

PLAYER	CLUB	H.S.	INNS	N.O.	RUNS	AVE
A Houston	Miranda	97x	10	6	274	68.5
A Harvey	Sylvania	36	7	4	159	53.0
R Falkenmire	Cronulla Seagulls	69x	6	2	147	36.75
E Langham	Como Jannali	55	7	1	179	29.83
D Bevan	Engadine	33	10	2	148	18.50

## BOWLING

Association Records:				
Bowling Average	N Nolan	Sylvania	90/91	2.78
Bowling Aggregate	S Hooper	Grays Point	89/90	23

PLAYER	CLUB	OVERS	MDNS	WKTS	RUNS	AVE
E Langham	Como Jannali	52.3	17	17	74	4.35
M Doyon	Sylvania	79	27	22	115	5.22
R Falkenmire	Cronulla Seagulls	50	11	15	89	5.93
D McGill	Sylvania	65	15	17	117	6.88
A Harvey	Sylvania	41	9	10	75	7.5
A Rahman	Miranda	39	7	15	113	7.53
B Jewell	Cronulla Seagulls	76	11	21	168	8.00
J Roast	Cronulla Seagulls	66	17	15	128	8.53
R Briggs	Como Jannali	45	9	10	86	8.6
A Houston	Miranda	75	18	16	139	8.68
M Fenning	Miranda	71	14	21	201	9.57
A Pippet	Sylvania	53	11	11	122	11.09
J Tench	Gynea	49	10	10	114	11.4
R Moar	Gynea	38	5	8	96	12.0
M Wackwitz	Engadine	50	8	9	131	14.55
M Bevan	Engadine	42	9	7	102	14.57
D Baird	Como Jannali	49	8	8	117	14.62
M Kirkham	Miranda	50	5	10	178	17.8
M Embleton	Engadine	47.1	12	6	121	20.16

## FINAL - Como Jannali vs Sylvania

## COMO JANNALI

BATSMAN	HOW OUT	BOWLER	RUNS
M Harrison	c Thompson	Harvey	7
N Watt	c Harris	Harvey	4
E Langham	c Harris	McGill	9
R Briggs	NOT OUT		12
J Teoh	NOT OUT		8
C Downing			
K Coles			
D Baird			
A McNaughton			
S Edson			
R Khilnani			
Sundries			13
			3 for 53

BOWLING	OVERS	MDS	WKTS	RUNS
A Harvey	7	1	2	13
D McGill	6	0	1	12
A Pippet	3	0	0	5
J Davis	1	0	0	4
M Doyon	2	0	0	8
W Rigby	1	0	0	9

## SYLVANIA

BATSMAN	HOW OUT	BOWLER	RUNS
M O'Rourke	c Dowling	Baird	0
D McGill	Bowled	Langham	1
A Harvey	Bowled	McNaughton	7
J Davis	Bowled	Baird	0
R Thompson	RUN OUT		0
A Pippet	c Baird	Baird	11
M Doyon	c Coles	B Khilnani	6
B Harris	Bowled	Baird	0
S Nicolopoulos	NOT OUT		3
M Plachetta	NOT OUT		2
W Rigby			
Sundries			12
			8 for 42

BOWLING	OVERS	MDNS	WKTS	RUNS
B Langham	7	5	1	3
D Baird	7	3	4	8
A McNaughton	7	3	1	5
R Briggs	7	2	0	7
J Teoh	3	0	0	7
R Khilnani	4	1	1	7

Como Jannali won by 86 runs

## 10A COMPETITION

## RAY THORBURN TROPHY\*

CLUB	W.O.	W.I.	L.O.	L.I.	POINTS
Illawong	2	7	-	1	52
Como Jannali	1	7	-	2	45
Caringbah Sports	-	5	1	4	29
Gymea	-	3	-	7	22
St Patricks	-	3	-	7	22
Engadine	-	2	2	6	15

N.B. Penalty points lost this grade.

Premiers:	Como				
Minor Premiers:	Illawong				
Batting Average:	J Drinkwater	Illawong		54.85	
Batting Aggregate:	J Drinkwater	Illawong		384	
Bowling Average:	C Davis	Como Jannali		5.2	
Bowling Aggregate:	J Drinkwater	Illawong		26	
Centuries:	S Reid	Como Jannali		101x	
Hat Tricks:	A Wallis	St Patricks		1	
Wicket Keepers Award:	A Wallis	St Patricks			
Most catches:	S Reid	Como Jannali		11	

Como Jannali &amp; Illawong took 48 catches

## BATTING

Association Records:					
Batting Average:	G Morriss	St Patricks	91/92		60.33
Batting Aggregate:	J Drinkwater	Illawong	92/93		384

PLAYER	CLUB	H.S.	INNS	N.O.	RUNS	AVE
J Drinkwater	Illawong	69x	11	4	384	54.85
S Reid	Como Jannali	101x	10	3	352	50.28
H McGeachie	Illawong	45x	10	4	250	41.66
P Culff	Como Jannali	56x	9	4	202	40.4
A Rine	Engadine	50	14	1	241	18.53

## BOWLING

Association Records:					
Bowling Average	B Ronald	Illawong	89/90		3.25
Bowling Aggregate	J Drinkwater	Illawong	92/93		39

PLAYER	CLUB	OVERS	MDNS	WKTS	RUNS	AVE
C Davis	Como Jannali	76	34	15	78	5.2
J Drinkwater	Illawong	107	39	26	140	5.38
D Symons	Illawong	61	14	15	91	6.06
D Wane	Como Jannali	62.4	21	14	95	6.78
N Cole	Como Jannali	61.4	20	13	100	7.69
S Reid	Como Jannali	64	17	8	97	12.12
S Spense	St Patricks	84.1	12	17	215	12.64
T Selvage	Engadine	58	4	12	157	13.08
K Hudson	Gymea	69	14	9	125	13.88
A Fleming	Caringbah Sports	85.3	13	11	159	14.45
C Jordan	Caringbah Sports	55	7	8	120	15.0
A Wallis	St Patricks	94	16	12	196	16.33
N Trajceviski	Gymea	82	19	9	149	16.55
A Cheema	Illawong	63.3	16	7	116	16.57
B Kennedy	Gymea	98	22	11	188	17.09
C Oates	Caringbah Sports	83.2	15	11	192	17.45

## FINAL - Como Jannali vs Illawong

## COMO JANNALI

BATSMAN	HOW OUT	BOWLER	RUNS
S Reid	c McGeachie	Cheema	2
P Culff	Bowled	Drinkwater	3
C Davis	RUN OUT		20
D Wane	Retired		13
N Cole	c McGeachie	McGovern	6
S Burns	Retired		6
D Hall	Retired		0
B McNaughton	Retired		1
R Ellis	Retired		0
M Pickering	NOT OUT		1
N Hogan	c Nail	Cheema	0
Sundries			22
			All out for 74

BOWLING	OVERS	MDS	WKTS	RUNS
J Drinkwater	10	3	1	12
A Cheema	9	2	2	15
D Symons	7	0	0	20
D Myers	3	1	0	2
N Koovarjee	2	0	0	6
I Cameron	2	0	0	4
M McGovern	2	0	1	5
J Nail	2	1	0	5
P Zanardo	2	2	0	0
C Varidel	2	0	0	3

## ILLAWONG

BATSMAN	HOW OUT	BOWLER	RUNS
J Drinkwater	c Cole	Cole	21
A Cheema	c Pickering	Davis	0
P Zanardo	Bowled	Burns	0
J Nail	c Hogan	Burns	0
H McGeachie	Bowled	Wane	10
D Myers	c Hogan	Wane	2
D Symons	c Davis	Cole	6
G Varidel	Bowled	Cole	0
M McGovern	RUN OUT		0
N Koovarjee	NOT OUT		2
I Cameron	c McNaughton	Cole	1
Sundries			7
			All out for 49

BOWLING	OVERS	MDNS	WKTS	RUNS
C Davis	10	4	1	15
S Burns	5	1	2	6
S Reid	8	2	0	11
D Wane	5	3	2	3
N Cole	6.5	2	4	12

Como Jannali won by 25 runs

## 10C COMPETITION

## "WALLY CROUCHER TROPHY"

CLUB	W.L.	L.I.	POINTS
Sylvania	5	-	25
St John Bosco	3	2	17
Cronulla Seagulls	3	2	17
Illawong	2	3	13
Miranda	2	3	13
Heathcote	-	5	5

Premiers:	St John Bosco		
Minor Premiers:	Sylvania		
Batting Average:	M Friend	Heathcote	40.00
Batting Aggregate:	M Friend	Heathcote	120
Bowling Average:	J Collins	Sylvania	5.42
Bowling Aggregate:	A Deller	Cronulla Seagulls	13
Centuries:	NIL		
Hat Tricks:	NIL		
Most catches:	B King	Cronulla Seagulls	7
	M O'Neill	St Patricks	7

Cronulla Seagulls took 26 catches

## BATTING

PLAYER	CLUB	H.S.	INNS	N.O.	RUNS	AVE
M Friend	Heathcote	28x	7	4	120	40.0
J Vandenberg	St John Bosco	57x	3	1	77	38.5
J Glenn	Illawong	45x	5	2	109	36.33
S Moodliar	Miranda	32	6	2	102	25.5
K Fleming	Sylvania	34	4	1	73	24.33
B King	Cronulla Seagulls	37	5	0	106	21.2
B McIlvride	Illawong	29x	5	1	79	19.75
A Mayhew	Cronulla Seagulls	39	6	2	76	19.0
J Gallyott	Cronulla Seagulls	31x	6	1	73	14.65

## BOWLING

PLAYER	CLUB	OVERS	MDNS	WKTS	RUNS	AVE
J Collins	Sylvania	19	4	7	38	5.42
K Fleming	Sylvania	20	4	6	40	6.67
A Deller	Cronulla Seagulls	36	4	13	91	7.00
M Friend	Heathcote	29	5	7	58	8.28
S Moodliar	Miranda	31	4	7	60	8.57
J Lidbetter	Miranda	23	1	8	81	10.12
P Barclay	Heathcote	20	1	4	48	12.00
J Gallyott	Cronulla Seagulls	47	5	9	110	12.22
J Glenn	Illawong	23	5	4	51	12.75
A Pilgrim	Illawong	22	3	4	70	17.50
B King	Cronulla Seagulls	24	0	4	77	19.25
J Myers	Miranda	22	0	4	81	20.25
S Kavanagh	Miranda	22	0	3	84	28.00
B McIlvrides	Illawong	22	5	2	68	34.00

## FINAL - St John Bosco vs Sylvania

## ST JOHN BOSCO

BATSMAN	HOW OUT	BOWLER	RUNS
M O'Neill	NOT OUT		57
G Henry	Bowled	Collins	5
A McEvoy	c Watkins	Collins	16
J Vandenberg	RUN OUT		2
G Robson	Bowled	Fleming	0
D Stewart	NOT OUT		5
Sundries			24
			4 for 109

BOWLING	OVERS	MDS	WKTS	RUNS
E Morrison	7	1	0	19
N Ho	7	0	0	23
J Collins	7	0	2	18
S Burgess	6	0	0	18
K Fleming	5	0	1	16
B Smith	2	0	0	5
C Young	1	0	0	7

## SYLVANIA

BATSMAN	HOW OUT	BOWLER	RUNS
E Morrison	c O'Neill	O'Neill	4
B Smith	c Vandenberg	Henry	3
B Rooke	Bowled	Vandenberg	2
J Collins	c McEvoy	O'Neill	0
S Burgess	Bowled	Vandenberg	5
K Fleming	Bowled	Vandenberg	5
M Ettrick	Bowled	Henry	10
N Ho	c Vandenberg	Robson	5
C Sponiar	Bowled	Robson	0
C Young	Bowled	Robson	7
N Young	NOT OUT		2
Sundries			23

All out for 66

BOWLING	OVERS	MDNS	WKTS	RUNS
G Henry	7	1	2	9
M O'Neill	7	1	2	18
A McEvoy	4	0	0	10
J Vandenberg	4	0	3	17
G Robson	4	0	3	7

St John Bosco won by 43 runs

## 100 COMPETITION

## "MIRANDA GLAZING TROPHY"

CLUB	W.I.	L.I.	POINTS
Caringbah Sports	5	-	25
Illawong (1)	4	1	21
Como Jannali	2	3	13
Sylvania	2	3	12
Illawong (2)	1	4	9
St Patricks	1	4	9

N.B. Penalty points lost this grade.

Premiers:	Caringbah Sports		
Batting Average:	A McBarron	Illawong	111.00
Batting Aggregate:	R Edwards	Como Jannali	115
Bowling Average:	M Hughston	Caringbah Sports	2.5
Bowling Aggregate:	M Hughston	Caringbah Sports	12
Centuries:	NIL		
Hat Tricks:	NIL		
Most catches:	R Edwards	Como Jannali	6

Como Jannali took 13 catches

## BATTING

PLAYER	CLUB	H.S.	INNS	N.O.	RUNS	AVE
A McBarron	Illawong (1)	43x	3	2	111	111.00
M Hughston	Caringbah Sports	48	3	2	85	85.00
S Cain	Caringbah Sports	31x	3	2	70	70.00
B Warton	Illawong (1)	37	3	1	87	43.5
R Edwards	Como Jannali	46x	4	1	115	38.33
S Vella	Illawong (1)	43x	4	1	91	30.3
S Wright	Caringbah Sports	41	3	0	70	25.00
M Ettrick	Sylvania	47	4	0	70	17.5
T Stafford	Illawong (2)	47	6	0	95	15.83

## BOWLING

PLAYER	CLUB	OVERS	MDNS	WKTS	RUNS	AVE
M Hughston	Caringbah Sports	22	5	12	30	2.5
S Vella	Illawong (1)	26	5	10	46	4.6
D Hall	Como Jannali	22	4	6	41	6.83
B Warton	Illawong (1)	25	4	8	56	7.0
S Cain	Caringbah Sports	19	3	5	37	7.4
D Marandola	Como Jannali	21.3	5	5	42	8.4
B Cooper	Illawong (2)	23	3	4	44	11.0
T Carr	Illawong (1)	24	3	5	63	12.6
S Morriss	St Patricks	29	4	5	69	13.8
T Stafford	Illawong	20	0	4	62	15.55
A Gillett	St Patricks	21	4	3	51	17.0
B Ferguson	Sylvania	30	2	6	103	17.16
R Blaney	St Patricks	29	1	5	93	18.6
A White	Illawong (1)	26	3	3	59	19.66
M Stevens	Illawong (2)	19	0	3	68	22.66
R Edwards	Como Jannali	20	3	3	74	24.66

## FINAL - Caringbah Sports vs Illawong

## CARINGBAH SPORTS

BATSMAN	HOW OUT	BOWLER	RUNS
M Hughston	Bowled	Vella	11
S Cain	Bowled	White	37
S Wright	NOT OUT		59
M Said	NOT OUT		36
S Rafique			
P O'Flynn			
M Beare			
P Burns			
L Hankinson			
T McJannett			
A Towle			
Sundries			16
		2 for	159

BOWLING	OVERS	MDNS	WKTS	RUNS
S Vella	7	0	1	32
D Warton	7	0	0	32
A White	7	1	1	30
T Carr	6	0	0	34
A McBarron	7	0	0	26
I Small	1	0	0	3

## ILLAWONG (1)

BATSMAN	HOW OUT	BOWLER	RUNS
S Vella	c Towle	Wright	14
A McBarron	NOT OUT		27
B Warton	NOT OUT		21
L Brown			
T Carr			
L Stewart			
I Small			
A White			
C Iland			
G Norman			
C Brown			
Sundries			24
		1 for	61

BOWLING	OVERS	MDNS	WKTS	RUNS
M Hughston	7	1	0	8
S Cain	7	0	0	19
M Said	7	1	0	22
S Wright	5	2	0	11
P Burns	3	0	0	8
S Rafique	2	0	0	3
M Beare	1	0	0	8
L Hankinson	1	0	0	5
T McJannett	1	0	0	1

Caringbah Sports won by 73 runs



# GoCola

HAVE A  AUSTRALIA

PRODUCT OF THE SUTHERLAND SHIRE

THE *GoCola* COMPANY OF AUSTRALIA

BUY DIRECT FROM THE FACTORY AT  
**WHOLESALE PRICES**

- \* Soft Drinks
- \* Cordials
- \* Cans
- \* Mixer Drinks
- \* Low Calories
- \* Pure Fruit Juices

Sugar  A natural part of life

BSD  
**BERTS**

45-47 ALEXANDER AVE, TAREN POINT  
TELEPHONE: 525 3033

Open 7.30 a.m. to 5.00 p.m. Mon. to Fri.  
7.30 a.m. to 11.30 a.m. Sat.

## HONOUR ROLL

### CLUB CHAMPIONS

#### "BERTSHELL TROPHY"

1965/66	Jannali
1966/67	Jannali
1967/68	Cronulla RSL
1968/69	Sylvania Heights
1969/70	Sylvania Heights
1970/71	Engadine Dragons
1971/72	Engadine Dragons
1972/73	Miranda Magpies
1973/74	Engadine Dragons
1974/75	Engadine Dragons
1975/76	Engadine Dragons
1976/77	Engadine Dragons
1977/78	Miranda Magpies
1978/79	Engadine Dragons
1979/80	Como
1980/81	St Patricks
1981/82	Caringbah Sports
1982/83	Sylvania Heights
1983/84	Gymea Bay
1984/85	Sylvania Heights
1985/86	Sylvania Heights
1986/87	Caringbah Sports
1987/88	Caringbah Sports
1988/89	Caringbah Sports
1989/90	Caringbah Sports
1990/91	Gymea Bay
1991/92	Caringbah Sports
1992/93	Caringbah Sports

**CRICKETER OF THE YEAR  
"JOHN WOODHOUSE MEMORIAL TROPHY"**

1961/62.....	R Tozer.....	Miranda Magpies
1962/63.....	M King.....	St Patricks
1963/64.....	B Davidson.....	Miranda Magpies
1964/65.....	B McManus.....	Engadine Dragons
1965/66.....	G Bailey.....	Jannali
1966/67.....	P Venn.....	St Patricks
1967/68.....	M Ray.....	Caringbah D.L.S.
1968/69.....	P Hart.....	Sylvania Heights
1969/70.....	J Dyson.....	Jannali
1970/71.....	S Anderson.....	Sylvania Heights
1971/72.....	A Hilditch.....	Caringbah Sports
1972/73.....	B Handley.....	Gynea Bay
1973/74.....	B Handley.....	Gynea Bay
1974/75.....	K Hudson.....	Miranda Magpies
1975/76.....	G Whatley.....	Miranda Magpies
1976/77.....	P Bishell.....	Gynea Bay
1979/80.....	M Gardner.....	Miranda Magpies
1980/81.....	J Steed.....	Caringbah Sports
1981/82.....	K Tuite.....	St Patricks
1982/83.....	A Quinn.....	St Patricks
1983/84.....	M Condon.....	Jannali
1984/85.....	J Smith.....	Como
1985/86.....	C Parsons.....	Engadine
1986/87.....	D Wallace.....	St Patricks
1987/88.....	S Duff.....	St Patricks
1988/89.....	N Morando.....	Engadine
1989/90.....	M O'Brien.....	St John Bosco
1990/91.....	C Haran.....	St John Bosco
1991/92.....	J Holley.....	Gynea Bay
1992/93.....	M. Bradley.....	Caringbah Sports

**PAST ASSOCIATION OFFICE BEARERS**

**PRESIDENTS:**

L. Ticehurst	1957/58	A. Tredinnick	1958/59
J. Daly	1958/59	N. Davies	1969/72
F. Pattinson	1972/75	K. Prendergast	1975/78
D. Clark	1978/81	D. Clark (part)	1981/82
K. Whatley	1981/93		

**SENIOR VICE-PRESIDENTS:**

R. Longbottom	1959/62	K. Hopkins	1962/63
J. Turpie	1963/65	G. Merritt	1965/66
G. Thomson	1966/69	L. Ray	1969/70
F. Pattinson	1970/72	K. Prendergast	1972/75
L. Handley	1975/77	D. Clark	1977/78
K. Whatley	1978/81	R. Hill	1981/82
K. Gardner	1982/90	I. Chalmers	1990/92
H Peters	1991/93		

**JUNIOR VICE-PRESIDENTS:**

K. Hopkins	1959/60	J. Dunstan	1960/61
J. Turpie	1961/63	L. Flynn	1963/65
G. Thomson	1965/66	N. Davies	1966/69
M. Edson	1969/70	K. Prendergast	1970/72
R. Hilditch	1972/73	L. Handley	1973/75
D. Clark	1975/77	K. Whatley	1977/78
R. Moore	1978/81	K. Gardner	1981/82
B. Quinn	1982/92	A. Craston	1992/93

**SECRETARIES:**

A. Tradinnick	1957/58	J. Moodie	1958/63
M. Edson	1963/69	R. Hilditch	1969/72
J. Ruty	1972/80	D. Masters	1980/90
A. Craston	1990/92	B. Probert	1992/93

**COMPETITION SECRETARIES:**

F. Malbon	1969/75	E. Townsend	1975/77
J. Lynch	1977/82	G. Berry	1982/85
J. Lynch	1985/88	A. Craston	1988/90
P. Schofield	1990/93		

ALEXANDER AVE, YAREN POINT  
TELEPHONE: 835 7011

**PAST ASSOCIATION OFFICE BEARERS (Cont'd)****ASSISTANT SECRETARIES:**

E. Hilzinger	1960/61	L. Flynn	1961/63
R. Tumeth	1963/65	M Hart	1965/66
W. Haines	1966/67	W. Cox	1967/69
G. Thomson	1969/72	Mrs. G. Lawton	1972/75
G. Ogilvie to Dec.	1975	J. Lynch from Dec.	1975/77
K. Moxham	1977/78	D. Trevor	1978/80
G. Marshall	1980/85	W. Straker	1985/89
I. Chalmers	1989/92	B. Phillips	1992/93

**TREASURERS:**

J. Woodhouse	1957/61	E. Hilzinger	1961/66
C. Taylor	1966/71	G. Anderson	1971/72
C. Lawton	1972/75	M. Fordyce	1975/76
Mrs. I Ruty	1976/80	S. Steed	1980/84
D. Thwaites	1984/86	R. Brennan	1986/93

**RECORDERS:**

J. Moodie	1957/58	W. Croucher	1958/65
F. Malbon	1965/71	E. Townsend	1972/75
K. Whatley	1975/77	B. Doherty	1977/79
G. Berry	1979/82	B. Davison	1980/81
D. Thwaites	1982/84	B. Doherty	1982/83
C. Paddy	1983/84	C. Leeke	1984/85
W. Giles	1984/85	J. Scott	1984/90
M. Stanford	1984/90	J. Lynch	1985/86
W. Andrews	1986/90	I. Chalmers	1985/89
C. McDonough	1990/91	B. Williamson	1990/91
J. Chalmers	1989/93	B. Stanford	1990/93

**REGISTRARS:**

G. Merritt	1961/65	A. Mahoney	1965/66
N. Davies	1966/68	J. Ruty	1968/72
I. Ruty	1972/76	R. Hill	1968/72
P. Witcombwe	1980/85	L. Buhagiar	1985/88
B. Stanford	1988/90	B. Probert	1990/92
M. O'Brien	1992/93		

**PUBLICITY OFFICERS:**

R. Tumeth	1963/65	J. Ruty	1965/71
J. Bannon	1971/73	K. Whatley	1972/73
B. Rosen	1974/75	J. Dolan-Brown	1975/83
T. Gleeson	1983/86	J. Chalmers	1986/89
T. Gleeson	1989/90	B. Ross	1991/93

**PAST ASSOCIATION OFFICE BEARERS (Cont'd)****COMMITTEE MEN:**

S. Astle	1957/59	S. Neilsen	1957/59
J. Jamieson	1957/58	R. Smith	1958/59
A. Peterson	1958/60	W. Croucher	1959/60
R. Longbottom	1959/60	K. Killey	1960/62
K. Collis	1960/61	B. McManus	1960/61
G. Merritt	1960/62	K. Hopkins	1961/62
G. Thomson	1962/63	B. McManus	1962/63
W. Bailey	1962/64	G. Thomson	1964/65
C. Johnson	1963/65	L. Knapp	1963/64
N. Druery	1965/67	A. Mahoney	1964/65
J. Turpie	1965/66	N. Druery	1971/72
L. Ray	1966/69	N. Davies	1965/68
L. Piper	1969/72	G. Anderson	1967/69
J. Edwards	1968/69	F. Pattinson	1969/70
J. Bannon	1972/73	G. Anderson	1970/71
G. Ogilvie	1972/75	C. Keenan	1971/72
W. Haines	1972/73	L. Handley	1972/73
T. Wagner	1974/76	T. Jones	1972/73
S. Steed	1975/80	K. Whatley	1974/75
R. Moore	1976/78	R. Hill	1974/75
G. Marshall	1979/80	K. Gardner	1975/81
A. Willis	1982/87	G. Berry	1978/79
J. Hutcheon	1983/84	W. Lawler	1980/90
M. Magee	1987/89	C. Mann	1982/87
P. Schofield	1989/90	W. Foster	1987/89
B. Straker	1989/90	G. Blakeley	1991/92
R. Eaglesham	1991/92	B. Phillips	1991/92
I. Chalmers	1992/93	V. Routh	1992/93

**PREMIERSHIP WINNERS**

SEASON	16A	16B	16C	16D	16A	16B	16C	16D	16E
1957/58	MIR RANGERS	-	-	-	EVOCA SUTH	-	-	-	-
1958/59	MIR MAGPIES	-	-	-	MIR MAGPIES	-	-	-	-
1959/60	C'BAH SPTS	-	-	-	MIR MAGPIES	-	-	-	-
1960/61	MIR MAGPIES	-	-	-	MIR MAGPIES	EVOCA SUTH	-	-	-
1961/62	MIR MAGPIES	-	-	-	MIR MAGPIES	C'BAH DLS	-	-	-
1962/63	MIR MAGPIES	BOYS' TOWN	-	-	C'BAH SPTS	SYLVANIA	CRON RSL (1)	-	-
1963/64	MIR MAGPIES	JANNALI	-	-	C'BAH SPTS	C'BAH SPTS	C'BAH SPTS	-	-
1964/65	MIR MAGPIES	WORONORA	-	-	MIR MAGPIES	MIR MAGPIES	SYLVANIA	-	-
1965/66	JANNALI	KIRRAWEE	-	-	MIR MAGPIES	ENGADINE	COMO	-	-
1966/67	MIR MAGPIES	C'BAH SPTS	-	-	MIR MAGPIES	JANNALI (1)	COMO	-	-
1967/68	ST PATS	SYLVANIA	-	-	C'BAH SPTS	SYLVANIA	ST PATS	-	-
1968/69	SYLVANIA	-	-	-	C'BAH SPTS	ENGADINES	YLVANIA	MIR MAGPIES	-
1969/70	SYLVANIA	C'BAH DLS	-	-	CRON RSL	GYMEA BAY	BOYS'TOWN	-	-
1970/71	SYLVANIA	C'BAH DLS	-	-	JANNALI	ST PATS	MIR MAGPIES	ENGADINE	-
1971/72	SYLVANIA	ENGADINE	-	-	ENGADINE	C'BAH SPTS	C'BAH SPTS	-	-
1972/73	MIR MAGPIES	SYLVANIA	BOYS'TOWN	-	C'BAH SPTS	GYMEA BAY	CRON RSL	C'BAH SPTS	JANNALI
1973/74	GYMEA BAY	ST PATS	BOYS' TOWN	-	MIR MAGPIES	SYLVANIA	C'BAH SPTS	GYMEA BAY	HCOTE
1974/75	MIR MAGPIES	JANNALI	-	-	C'BAH SPTS	C'BAH DLS	C'BAH SPTS	ENGADINE	-
1975/76	C'BAH SPTS	COMO	SYLVANIA	-	SYLVANIA	ENGADINE	SYLVANIA	ENGADINE	-
1976/77	C'BAH SPTS	C'BAH SPTS	ENGADINE	-	MIR MAGPIES	ENGADINE	ENGADINE	MIR MAGPIES	-
1977/78	ENGADINE	MIR MAGPIES	SYLVANIA	-	C'BAH SPTS	CRON RSL	HCOTE	CRON RSL	CR-SUTH LEAG
1978/79	ENGADINE	ST PATS	GYMEA BAY	-	C'BAH SPTS	LOFTUS	ST PATS	CR-SUTH LEAG	BOYS' TOWN
1979/80	C'BAH SPTS	C'BAH SPTS	CR-SUTH LEAG	-	ST PATS	SYLVANIA	SYLVANIA (1)	C'BAH SPTS	BOYS' TOWN
1980/81	C'BAH SPTS	GYMEA BAY	MIR MAGPIES	-	ST PATS	ENGADINE	ILLAWONG	ENGADINE	SYLVANIA (1)
1981/82	ST PATS	ENGADINE	SYLVANIA	-	C'BAH SPTS	ENGADINE	SYLVANIA	C'BAH SPTS	C'BAH DLS
1982/83	SYLVANIA	C'BAH DLS	CR S'GULLS	-	C'BAH DLS	GYMEA BAY	ST PATS (1)	SYLVANIA (1)	-
1983/84	ST PATS	SYLVANIA	SYLVANIA	-	ST PATS	SYLVANIA (1)	GYMEA BAY	ST PATS	GYMEA BAY
1984/85	ST PATS	SYLVANIA (1)	HCOTE	-	SYLVANIA	LOFTUS	SYLVANIA (2)	JANNALI	SYLVANIA (1)
1985/86	ILLAWONG	C'BAH DLS	SYLVANIA (1)	ST PATS	SYLVANIA	HCOTE	ST PATS	C'BAH SPTS	SYLVANIA
1986/87	SYLVANIA	SYLVANIA	HCOTE	SYLVANIA	GYMEA BAY	GYMEA BAY	SYLVANIA	ST J BOSCO	ST PATS
1987/88	ST PATS	ST PATS	C'BAH DLS	SYLVANIA	ENGADINE	C'BAH SPTS	ENGADINE	SYLVANIA	ST PATS
1988/89	C'BAH SPTS	MIR MAGPIES	JANNALI	-	ST J BOSCO	ILLAWONG	GYMEA BAY	MARTON	-
1989/90	GYMEA BAY	CAR DLS	JANNALI	-	CAR SPTS	ST PATS	GYMEA BAY	SYLVANIA	-
1990/91	GYMEA BAY	GYMEA BAY	-	-	C'BAH SPTS	ST J BOSCO	C'BAH DLS	ILLAWONG	-
1991/92	GYMEA BAY	MARTON	C'BAH SPTS	-	C'BAH SPTS	MIRANDA	ENGADINE	-	-
1992/93	C'BAH SPTS	C'BAH SPTS	-	-	C'BAH SPTS	ST PATS	C'BAH SPTS	MIRANDA	-

**PREMIERSHIP WINNERS**

SEASON	12A	12B	12C	12D	12E	12E	10A	10B	10C	10D	10E
1957/58	MIR MAGPIES	-	-	-	-	-	-	-	-	-	-
1958/59	ST PATS	-	-	-	-	-	-	-	-	-	-
1959/60	C'BAH SPTS	-	-	-	-	-	C'BAH SPTS	-	-	-	-
1960/61	KIRRAWEE	CRON RSL (A)	-	-	-	-	MIR MAGPIES	-	-	-	-
1961/62	C'BAH SPTS	JANNALI	CRON RSL	-	-	-	MIRANDA	CRON RSL (B)	-	-	-
1962/63	MIR MAGPIES	KIRRAWEE	KIRRAWEE	-	-	-	C'BAH SPTS	CRON RSL (2)	-	-	-
1963/64	MIR MAGPIES	CRON RSL	CRON RSL	-	-	-	CRON RSL	CRON RSL	-	-	-
1964/65	MIR MAGPIES	CRON RSL (1)	TAREN PT	SUTH'G PT	-	-	CRON RSL	JANNALI	CRON RSL	-	-
1965/66	C'BAH SPTS	KIRRAWEE	SYLVANIA	JANNALI	-	-	CRON RSL	JANNALI	CRON RSL	-	-
1966/67	GYMEA BAY	KIRRAWEE	CRON RSL	GYMEA BAY	-	-	MIRANDA	C'BAH DLS	WORON RSL	-	-
1967/68	CRON RSL	ENGADINE	WORON RSL	ST PATS	-	-	JANNALI	SYLVANIA	COMO	-	-
1968/69	JANNALI	C'BAH DLS	COMO	C'BAH SPTS	-	-	WORON RSL	ENGADINE	SYLVANIA (2)	-	-
1969/70	ENGADINE	SYLVANIA	MIRANDA	C'BAH SPTS	MIRANDA	-	SYLVANIA	C'BAH DLS	ST J BOSCO	CRON RSL	-
1970/71	ENGADINE	ST J BOSCO	SUTH'G PT	MIR MAGPIES	-	-	C'BAH SPTS	ENGADINE	MIRANDA	-	-
1971/72	MIRANDA	ST J BOSCO	C'BAH SPTS	MIRANDA	-	-	MIRANDA	ST PATS	SYLVANIA	C'BAH SPTS	-
1972/73	C'BAH SPTS	COMO	GYMEA BAY	C'BAH SPTS	KURNELL	-	SYLVANIA	C'BAH SPTS	ENGADINE	ENGADINE	-
1973/74	ENGADINE	JANNALI	GYMEA BAY	MIRANDA	ENGADINE	-	ENGADINE	HEATHCOTE	ENGADINE	ST PATS	-
1974/75	C'BAH SPTS	ST PATS	ENGADINE	C'BAH SPTS	-	-	SYLVANIA	GRAYS PT	ST PATS	-	-
1975/76	ENGADINE	CRON RSL	BULLDOGS	C'BAH SPTS	GYMEA BAY	-	ST PATS	HEATHCOTE	CRON RSL	ENGADINE	-
1976/77	ST PATS	BULLDOGS	ST J BOSCO	MIRANDA	MIRANDA	-	ENGADINE	GRAYS PT	MIRANDA	-	-
1977/78	MIRANDA	GYMEA BAY	C/SUTH LEAG	C'BAH SPTS	SYLVANIA (2)	-	C'BAH SPTS	C'BAH SPTS	ENGADINE	JANNALI	-
1978/79	ENGADINE	CRON RSL	C/SUTH LEAG	ST PATS	LOFTUS	-	ENGADINE	C'BAH SPTS	COMO 100/2	ST PATS	-
1979/80	C'BAH SPTS	SYLVANIA	ILLAWONG	C'BAH SPTS	ST PATS	-	COMO	CRON RSL	ST PATS	MIRANDA	-
1980/81	ENGADINE	C'BAH DLS	ST PATS	CRON RSL	ST PATS	-	SYLVANIA	C'BAH SPTS	GYMEA BAY	SYLVANIA	-
1981/82	ST PATS	GYMEA BAY	ST J BOSCO	GYMEA BAY	SYLVANIA (2)	-	SYLVANIA	C/SUTH LEAG	SYLVANIA	ENGADINE	-
1982/83	SYLVANIA	C'BAH DLS	SYL1/MIR	ENGADINE	BUNDEENA	-	SYLVANIA	ST PATS	MIRANDA	SYLVANIA	CAR SPTS
1983/84	SYLVANIA	SYLVANIA	JANNALI	ILLAWONG	ST PATS	-	SYLVANIA	GYMEA BAY	HEATHCOTE	ILLAWONG	CAR SPTS
1984/85	SYLVANIA	ST J BOSCO	SYLVANIA	SYLVANIA	ST PATS	MIRANDA	C'BAH SPTS	SYLVANIA	SYLVANIA	SYLVANIA	MIRANDA
1985/86	SYLVANIA	CR S'GULLS	MARTON	ST PATS	SYLVANIA	GRAYS PT	ILLAWONG	C'BAH DLS	GYMEA BAY	ENGADINE	ST J BOSCO
1986/87	ST J BOACO	SYLVANIA	CR S'GULLS	GRAYS PT	SYLVANIA	-	C'BAH SPTS	MIRANDA	MIRANDA	C'BAH SPTS	-
1987/88	C'BAH SPTS	GYMEA BAY	HEATHCOTE	C'BAH DLS	GYMEA BAY	-	C'BAH SPTS	-	MARTON	C'BAH SPTS	-
1988/89	C'BAH SPTS	ST PATS	CR S'GULLS	ST J BOSCO	-	-	C'BAH SPTS	-	CR S'GULLS	ILLAWONG	-
1989/90	C'BAH SPTS	MARTON	C'BAH SPTS	CR S'GULLS	C S'GULLS(2)	-	ILLAWONG	-	MARTON	C'BAH SPTS	-
1990/91	C'BAH SPTS	MIRANDA	ILLAWONG	SYLVANIA	C.SPTS/ILL	-	C'BAH SPTS	-	SYLVANIA	COMO/JANLI	-
1991/92	ILLAWONG	ST.PATS	ENGADINE	ILLAWONG	-	-	C'BAH SPTS	-	SYLVANIA	C'BAH SPTS	-
1992/93	SYLVANIA	C'BAH SPTS	MIRANDA	COMO/JANN	-	-	COMO/JANN	-	ST J BOSCO	C'BAH SPTS	-

## NOTICE TO ADVERTISERS

The Trade Practices Act, 1974, came into force on October 1, 1974. There are important new provisions in that Act which contain strict regulations on advertising and all advertisers and advertising agents are advised to study these provisions very carefully.

It can be an offence for anyone to engage, in trade or commerce, in conduct "misleading or deceptive". In particular Section 53 contains prohibitions for doing any of the following in connection with the supply of goods or services or in connection with the promotion, by any means, of the supply or use of goods or services.

- (a) Falsely represent that goods or services are of a particular standard, quality or grade, or that goods are of a particular style or model.
- (b) Falsely represent that goods are new.
- (c) Represent that goods or services have sponsorship, approval, performance characteristics, accessories uses or benefits they do not have.
- (d) Represent that he or it has a sponsorship, approval, or affiliation he or it does not have.
- (e) Make false or misleading statements concerning the existence of, or amounts of price reductions.
- (f) Make false or misleading statements concerning the need for any goods, services, replacements or repairs.
- (g) Make false or misleading statements concerning the existence or effect of any warranty or guarantee.

### PENALTY:

For an individual	-	\$10,000 or 6 months imprisonment.
For a corporation	-	\$50,000.

It is not possible for this company to ensure that advertisements which are published in this magazine comply with the Act and the responsibility must therefore be on the person, company or advertising agency submitting the advertisements for publication.

IN CASE OF DOUBT CONSULT YOUR LAWYER.

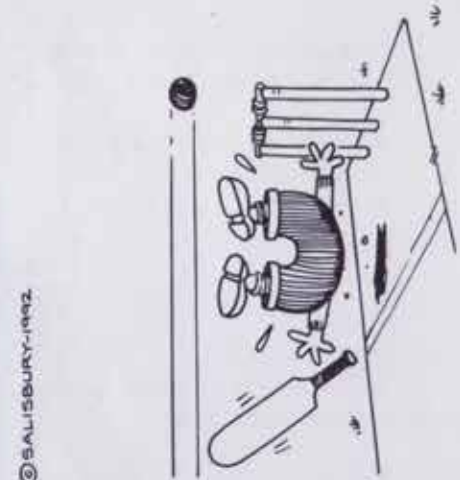
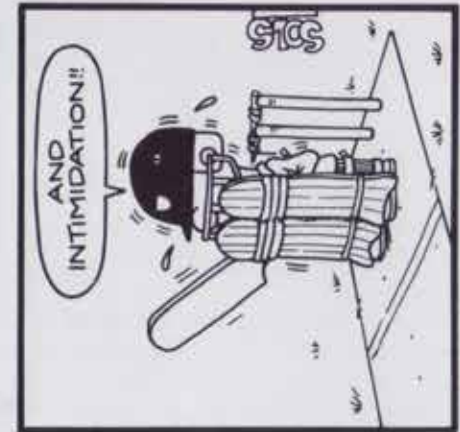
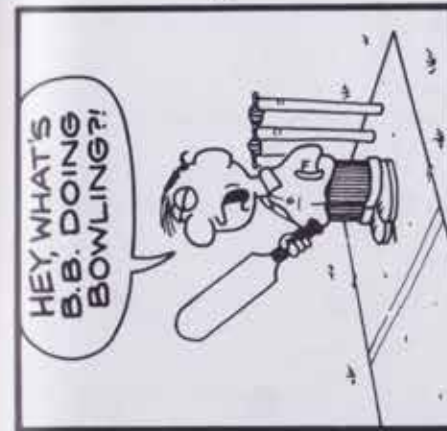

COACHING TIP

DEFENSIVE TECHNIQUE - SHOW THE BOWLER WHO'S BOSS



